

⚠ WARNING:

RECOGNIZE THIS SYMBOL AS AN INDICATION OF IMPORTANT SAFETY INFORMATION

⚠ WARNING

THESE INSTRUCTIONS ARE INTENDED AS AN AID TO QUALIFIED, LICENSED SERVICE PERSONNEL FOR PROPER INSTALLATION, ADJUSTMENT, AND OPERATION OF THIS UNIT. READ THESE INSTRUCTIONS THOROUGHLY BEFORE ATTEMPTING INSTALLATION OR OPERATION. FAILURE TO FOLLOW THESE INSTRUCTIONS MAY RESULT IN IMPROPER INSTALLATION, ADJUSTMENT, SERVICE, OR MAINTENANCE POSSIBLY RESULTING IN FIRE, ELECTRICAL SHOCK, PROPERTY DAMAGE, PERSONAL INJURY, OR DEATH.

Do not destroy this manual. Please read carefully and keep in a safe place for future reference by a serviceman.

[] indicates metric conversions.

92-104921-09-02 (3/15) Printed in USA

**AIR COOLED
CONDENSING UNITS**

INSTALLATION INSTRUCTIONS

**RA13, RA14 & RA16 MODEL SERIES –
13, 14 & 16 SEER**

**FEATURING INDUSTRY STANDARD
R-410A REFRIGERANT** 

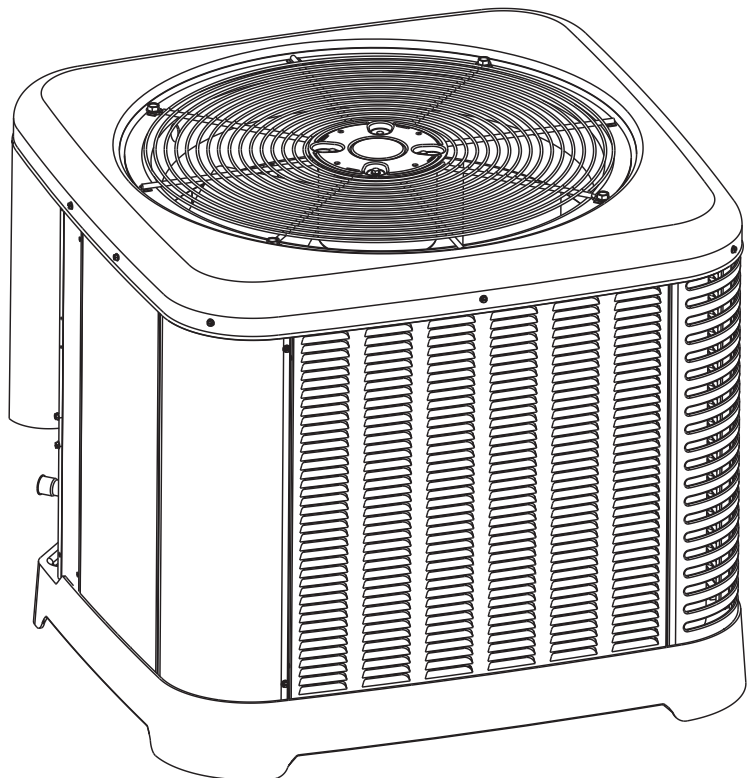

CONTENTS

Important Safety Information	3
General Information.....	4-7
Checking Product Received	4
Application	4
Electrical and Physical Data.....	5
Specifications.....	7
Proper Installation	7
Installation.....	8-25
Choosing a Location	8-9
Operational Issues.....	8
Corrosive Environment.....	8
For Units With	
Space Limitations.....	9
Customer Satisfaction Issues	9
Unit Mounting.....	9
Factory-Preferred	
Tie-Down Method.....	9
Tools and Refrigerant	10
Tools Required for Installing and	
Servicing R-410A Models	10
Specifications of R-410A	10
Quick-Reference	
Guide for R-410A	10
Replacement Units	11
Indoor Coil	11
Location.....	11
Interconnecting Tubing.....	11-25
Vapor and Liquid Lines	11
Maximum Length of Lines.....	11
Outdoor Unit Installed	
Above or Below Indoor Coil.....	14-16
Tubing Installation	17-22
Tubing Connections	24-25
Leak Testing	25
Wiring	26-27
Control Wiring	26
Conventional 24 VAC	
Thermostat Control Wiring	26
Thermostat Wiring Diagrams	26-27
Power Wiring	27
Grounding.....	27

Start-Up	28-32
Start-Up.....	28
Checking Airflow	28
Evacuation Procedure	29
Final Leak Testing.....	29
Checking	
Refrigerant Charge	30-32
Charging Units	
With R-410A Refrigerant	30
Confirm ID Airflow	
and Coils Are Clean	30
Measurement Device Setup.....	30
Charging by Weight.....	30
Gross Charging by Pressures	31
Final Charge by Subcooling	31
Finishing Up Installation	32
Components and Controls.....	33-34
Compressor	
Crankcase Heat (CCH).....	33
High- and Low-Pressure	
Controls (HPC and LPC).....	33
Hard-Start Components.....	34
Accessories	34
Time-Delay Control	34
Hard Start Components	34
Low Ambient Control (LAC)	34
Diagnostics	35-43
Cooling Mechanical	
Checks Flowchart	36
General Troubleshooting Chart	37
Service Analyzer Charts	38-42
Cooling/Heating Tips.....	43
Wiring Diagrams	44-45

IMPORTANT SAFETY INFORMATION

⚠️ WARNINGS:

- These instructions are intended as an aid to qualified, licensed service personnel for proper installation, adjustment, and operation of this unit. Read these instructions thoroughly before attempting installation or operation. **Failure to follow these instructions may result in improper installation, adjustment, service, or maintenance possibly resulting in fire, electrical shock, property damage, personal injury, or death.**
- **The unit must be permanently grounded. Failure to do so can cause electrical shock resulting in severe personal injury or death.**
- **Turn off electric power at the fuse box or service panel before making any electrical connections.**
- **Complete the ground connection before making line voltage connections. Failure to do so can result in electrical shock, severe personal injury, or death.**
- **Disconnect all power to unit before starting maintenance. Failure to do so can cause electrical shock resulting in severe personal injury or death.**
- **Never assume the unit is properly wired and/or grounded. Always test the unit cabinet with a noncontact voltage detector available at most electrical supply houses or home centers before removing access panels or coming into contact with the unit cabinet.**
- **Do not use oxygen to purge lines or pressurize system for leak test. Oxygen reacts violently with oil, which can cause an explosion resulting in severe personal injury or death.**
- The top of the scroll compressor shell is hot. Touching the compressor top may result in serious personal injury.
- The manufacturer's warranty does not cover any damage or defect to the unit caused by the attachment or use of any components, accessories, or devices (other than those authorized by the manufacturer) into, onto, or in conjunction with the heat pump. **You should be aware that the use of unauthorized components, accessories, or devices may adversely affect the operation of the heat pump and may also endanger life and property.** The manufacturer disclaims any responsibility for such loss or injury resulting from the use of such unauthorized components, accessories, or devices.

⚠️ CAUTIONS:

- R-410A systems operate at approximately 60% higher pressures (1.6 times) than R-22 systems. Do not use R-22 service equipment or components on R-410A equipment. Use appropriate care when using this refrigerant. Failure to exercise care may result in equipment damage or personal injury.
- Only match this outdoor unit with a matched indoor coil or air handler approved for use with this outdoor unit per the unit manufacturer's specification sheet. The use of unmatched coils or air handler will likely result in a charge imbalance between the cooling and heating modes which can cause unsatisfactory operation including a high-pressure switch lockout condition.
- Only use indoor coils approved for use on R-410A systems. An R-22 coil will have a TXV or fixed restrictor device that is not designed to operate properly in an R-410A system and will result in serious operational issues. The R-22 coil could also contain mineral oil which is incompatible with the POE oil used in R-410A systems and could result in reliability issues with the compressor and TXVs.
- When coil is installed over a finished ceiling and/or living area, it is required that a secondary sheet metal condensate pan be constructed and installed under the entire unit. Failure to do so can result in property damage.
- The compressor has an internal overload protector. Under some conditions, it can take up to 2 hours for this overload to reset. Make sure overload has had time to reset before condemning the compressor.

GENERAL INFORMATION

⚠WARNING:

Improper installation, or installation not made in accordance with these instructions, can result in unsatisfactory operation and/or dangerous conditions and can cause the related warranty not to apply.

The condensing unit is designed to operate with standard 24 VAC thermostats and air handlers or gas furnaces.

This installation instruction manual contains complete instructions for installation and setup using conventional 24 VAC controls. Please refer to the manufacturer's specification sheets for complete performance data, thermostat, and accessory listings.

The information contained in this manual has been prepared to assist in the proper installation, operation, and maintenance of the air conditioning system.

Read this manual and any instructions packaged with separate equipment required to make up the system prior to installation. Homeowner should retain this manual for future reference.

To achieve optimum efficiency and capacity, the matching indoor cooling coils listed in the manufacturer's specification sheet should be used.

Checking Product Received

Upon receiving unit, inspect it for any shipping damage. Claims for damage, either apparent or concealed, should be filed immediately with the shipping company. Check model number, electrical characteristics, and accessories to determine if they are correct. Check system components (indoor coil, outdoor unit, air handler/furnace, etc.) to make sure they are properly matched.

Application

Before specifying any air conditioning equipment, a survey of the structure and a heat gain calculation must be made. A cooling heat gain calculation determines the amount of heat needed to be removed. A heat gain calculation also calculates the extra heat load caused by sunlight and by humidity removal. These factors must be considered before selecting an air conditioning system to provide year-round comfort. The Air Conditioning Contractors of America (ACCA) J Manual method of load calculation is one recognized procedure for determining the heating and cooling load.

After the proper equipment combination has been selected, satisfying both sensible and latent requirements, the system must be properly installed. Only then can the unit provide the comfort it was designed to provide.

There are several factors that installers must consider.

- Outdoor unit location
- Indoor unit blower speed and airflow
- Proper equipment evacuation
- Supply and return air duct design and sizing
- Refrigerant charge
- System air balancing
- Diffuser and return air grille location and sizing

GENERAL INFORMATION



Electrical and Physical Data

RA13

Model Number	ELECTRICAL								PHYSICAL						
	Voltage	Phase	Freq	Compressor		Fan Motor Full Load Amperes (FLA)	Minimum Circuit Ampacity Amperes	Fuse or HACR Circuit Breaker		Outdoor Coil			Refrig. Per Circuit (oz.) [g]	Weight	
				Rated Load Amperes (RLA)	Locked Rotor Amperes (LRA)			Minimum Amperes	Maximum Amperes	Face Area Sq. Ft. [m ²]	No. Rows	CFM [L/s]		Net Lbs. [kg]	Shipping Lbs. [kg]
RA1318AJ1NA	208-230	1	60	9.7/9.7	48.0	0.70	13/13	20/20	20/20	5.9 [0.55]	1	2038 [962]	50 [1417]	120 [54.4]	127 [57.6]
RA1324AJ1NA	208-230	1	60	11.2/11.2	60.8	0.70	15/15	20/20	25/25	9.06 [0.84]	1	2325 [1097]	60 [1701]	135 [61.2]	142 [64.4]
RA1330AJ1NA	208-230	1	60	12.8/12.8	64.0	1.30	18/18	25/25	30/30	9.06 [0.84]	1	2796 [1320]	72 [2041]	156 [70.8]	163 [73.9]
RA1336AJ1NA	208-230	1	60	15.4/15.4	83.9	1.30	21/21	25/25	35/35	12.15 [1.13]	1	2898 [1368]	92 [2608]	157 [71.2]	164 [74.4]
RA1342AJ1NA	208-230	1	60	17.9/17.9	112.0	0.70	24/24	30/30	40/40	14.18 [1.32]	1	2466 [1164]	105 [2977]	188 [85.3]	195 [88.5]
RA1348AJ1NA	208-230	1	60	21.8/21.8	117.0	1.00	29/29	35/35	50/50	14.82 [1.38]	1	4144 [1953]	106 [3005]	195 [88.4]	202 [91.6]
RA1360AJ1NA	208-230	1	60	26.4/26.4	134.0	1.20	35/35	45/45	60/60	18.84 [1.75]	1	3868 [1825]	148 [4196]	228 [103.4]	235 [106.6]
RA1336AC1NB	208-230	3	60	10.4/10.4	73.0	1.30	15/15	20/20	20/20	12.15 [1.13]	1	2898 [1368]	92 [2608]	157 [71.2]	164 [74.4]
RA1342AC1NB	208-230	3	60	13.2/13.2	88.0	1.30	18/18	25/25	30/30	14.18 [1.32]	1	2466 [1164]	105 [2977]	188 [85.3]	195 [88.5]
RA1348AC1NB	208-230	3	60	13.7/13.7	83.1	1.00	19/19	25/25	30/30	14.82 [1.38]	1	4144 [1955]	106 [3005]	195 [88.4]	202 [91.6]
RA1360AC1NB	208-230	3	60	16/16	110.0	1.30	11/11	30/30	35/35	18.84 [1.75]	1	3868 [1825]	148 [4195]	228 [103.4]	235 [106.6]
RA1336AD1NB	460	3	60	5.8/5.8	38.0	0.50	8/8	15/15	15/15	12.15 [1.13]	1	2898 [1368]	92 [2608]	157 [71.2]	164 [74.4]
RA1342AD1NB	460	3	60	6.8/6.0	44.0	0.30	8/8	15/15	15/15	14.18 [1.32]	1	2466 [1164]	105 [2977]	188 [85.3]	195 [88.5]
RA1348AD1NB	460	3	60	6.2/6.2	41.0	0.50	9/9	15/15	15/15	14.82 [1.38]	1	4144 [1955]	106 [3005]	195 [88.4]	202 [91.6]
RA1360AD1NB	460	3	60	7.8/7.8	52.0	0.60	11/11	15/15	15/15	18.84 [1.75]	1	3868 [1825]	148 [4195]	228 [103.4]	235 [106.6]
RA1348AY1NB	575	3	60	4.8/4.8	33.0	1.00	8/8	15/15	15/15	14.82 [1.38]	1	4144 [1955]	106 [3005]	195 [88.4]	202 [91.6]
RA1360AY1NB	575	3	60	5.7/5.7	38.9	0.50	8/8	15/15	15/15	18.84 [1.75]	1	3868 [1825]	148 [4195]	228 [103.4]	235 [106.6]

RA14

Model Number	ELECTRICAL								PHYSICAL						
	Voltage	Phase	Freq	Compressor		Fan Motor Full Load Amperes (FLA)	Minimum Circuit Ampacity Amperes	Fuse or HACR Circuit Breaker		Outdoor Coil			Refrig. Per Circuit (oz.) [g]	Weight	
				Rated Load Amperes (RLA)	Locked Rotor Amperes (LRA)			Minimum Amperes	Maximum Amperes	Face Area Sq. Ft. [m ²]	No. Rows	CFM [L/s]		Net Lbs. [kg]	Shipping Lbs. [kg]
RA1418AJ1NA	208-230	1	60	9.7/9.7	48.0	0.60	13/13	20/20	20/20	9.06 [0.84]	1	2225 [1050]	68 [1928]	140 [63.5]	147 [66.7]
RA1424AJ1NA	208-230	1	60	11.2/11.2	60.8	0.70	15/15	20/20	25/25	11.14 [1.03]	1	2505 [1182]	72 [2041]	141 [64.0]	148 [67.1]
RA1430AJ1NA	208-230	1	60	12.8/12.8	64.0	0.70	17/17	20/20	25/25	12.15 [1.13]	1	2605 [1229]	87 [2466]	151 [68.5]	158 [71.7]
RA1436AJ1NA	208-230	1	60	14.1/14.1	77.0	0.60	19/19	25/25	30/30	14.82 [1.38]	1	3104 [1464]	106 [3005]	171 [77.6]	178 [80.7]
RA1442AJ1NA	208-230	1	60	17.9/17.9	112.0	1.20	24/24	30/30	40/40	16.15 [1.5]	1	3954 [1866]	119 [3374]	207 [93.9]	214 [97.1]
RA1448AJ1NA	208-230	1	60	19.9/19.9	109.0	1.00	26/26	35/35	45/45	18.84 [1.75]	1	4264 [2012]	129 [3657]	221 [100.2]	228 [103.4]
RA1460AJ1NA	208-230	1	60	23.7/23.7	152.5	1.00	31/31	40/40	50/50	21.54 [2.00]	1	4139 [1953]	162 [4593]	240 [108]	247 [112]
RA1436AC1NB	208-230	3	60	9.0/9.0	71.0	0.60	12/12	15/15	20/20	14.82 [1.38]	1	3104 [1464]	106 [3005]	171 [77.6]	178 [80.7]
RA1442AC1NB	208-230	3	60	13.2/13.2	88.0	1.20	18/18	25/25	30/30	16.15 [1.5]	1	3954 [1866]	119 [3374]	207 [93.9]	214 [97.1]
RA1448AC1NB	208-230	3	60	13.1/13.1	83.1	1.00	18/18	25/25	30/30	18.84 [1.75]	1	4264 [2012]	129 [3657]	221 [100.2]	228 [103.4]
RA1460AC1NB	208-230	3	60	15.9/15.9	110.0	1.00	21/21	25/25	35/35	21.54 [2.00]	1	4139 [1953]	162 [4593]	240 [108]	247 [112]
RA1436AD1NB	460	3	60	5.6/5.6	38.0	0.50	8/8	15/15	15/15	14.82 [1.38]	1	3104 [1464]	106 [3005]	171 [77.6]	178 [80.7]
RA1442AD1NB	460	3	60	6.0/6.0	44.0	0.60	9/9	15/15	15/15	16.15 [1.5]	1	3954 [1866]	119 [3374]	207 [93.9]	214 [97.1]
RA1448AD1NB	460	3	60	6.1/6.1	41.0	0.60	9/9	15/15	15/15	18.84 [1.75]	1	4264 [2012]	129 [3657]	221 [100.2]	228 [103.4]
RA1460AD1NB	460	3	60	7.1/7.1	52.0	0.50	10/10	15/15	15/15	21.54 [2.00]	1	4139 [1953]	162 [4593]	240 [108]	247 [112]

General Information

GENERAL INFORMATION



Electrical and Physical Data - cont.

RA16

General Information

Model Number	ELECTRICAL									PHYSICAL					
	Voltage	Phase	Freq	Compressor		Fan Motor Full Load Amperes (FLA)	Minimum Circuit Ampacity Amperes	Fuse or HACR Circuit Breaker		Outdoor Coil			Refrig. Per Circuit (oz.) [g]	Weight	
				Rated Load Amperes (RLA)	Locked Rotor Amperes (LRA)			Minimum Amperes	Maximum Amperes	Face Area Sq. Ft. [m ²]	No. Rows	CFM [L/s]		Net Lbs. [kg]	Shipping Lbs. [kg]
RA1618AJ1NA	208-230	1	60	9.0/9.0	47.5	0.70	12/12	15/15	20/20	12.15 [1.13]	1	2404 [1134]	82 [2325]	148 [67.1]	155 [70.3]
RA1624AJ1NA	208-230	1	60	10.3/10.3	61.6	0.60	14/14	20/20	20/20	14.82 [1.38]	1	2851 [1345]	87 [2466]	163 [73.9]	170 [77.1]
RA1630AJ1NA	208-230	1	60	12.8/12.8	67.3	1.40	18/18	25/25	30/30	16.15 [1.50]	1	3914 [1847]	113 [3203]	188 [85.3]	195 [88.4]
RA1636AJ1NA	208-230	1	60	15.4/15.4	83.9	3.50	23/23	30/30	35/35	18.85 [1.75]	1	4340 [2048]	108 [108]	200 [90.7]	207 [93.9]
RA1642AJ1NA	208-230	1	60	16.7/16.7	109.0	3.50	25/25	30/30	40/40	24.23 [2.25]	1	4450 [2100]	150 [4252]	246 [111.6]	253 [114.8]
RA1648AJ1NA	208-230	1	60	17.0/17.0	123.9	3.50	25/25	30/30	40/40	28.27 [2.63]	1	4658 [2198]	174 [4933]	261 [118.4]	268 [121.6]
RA1660AJ1NA	208-230	1	60	23.7/23.7	152.5	3.50	34/34	40/40	50/50	32.31 [3.00]	1	4776 [2254]	201 [5698]	289 [131.1]	296 [134.3]
RA1660BJ1NA	208-230	1	60	23.7/23.7	152.5	3.50	34/34	40/40	50/50	60.58 [5.63]	2	5124 [2418]	308 [8732]	300 [136]	307 [139.2]
RA1636AC1NB	208-230	3	60	10.4/10.4	73	3.50	17/17	20/20	25/25	18.85 [1.75]	1	4340 [2048]	108 [3062]	200 [90.7]	207 [93.9]
RA1642AC1NB	208-230	3	60	11.2/11.2	88	3.50	18/18	25/25	25/25	24.23 [2.25]	1	4450 [2100]	150 [4252]	246 [111.6]	253 [114.8]
RA1648AC1NB	208-230	3	60	13.6/13.6	83.1	3.50	21/21	25/25	30/30	28.27 [2.63]	1	4658 [2198]	174 [4933]	261 [118.4]	268 [121.6]
RA1660AC1NB	208-230	3	60	15.9/15.9	110	3.50	24/24	30/30	35/35	32.31 [3.00]	1	4776 [2254]	201 [5898]	289 [131.1]	296 [134.3]

UNIT MODEL NUMBER EXPLANATION

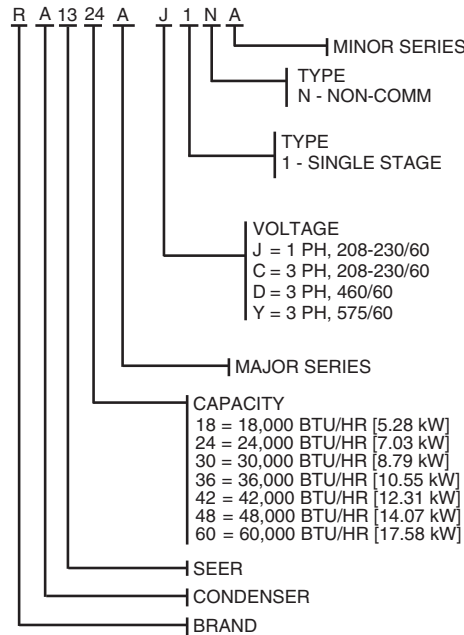

DIMENSIONAL DATA

RA13	18, 36	24, 30	42	48	60
Height "H" inches [mm]	27 [686]	25 [635]	27 [686]	27 [686]	31 [787]
Length "L" inches [mm]	29.75 [756]	29.75 [756]	33.75 [857]	33.75 [857]	35.75 [908]
Width "W" inches [mm]	29.75 [756]	29.75 [756]	29.75 [756]	33.75 [857]	33.75 [857]

GENERAL INFORMATION



Specifications

General Information

RA14	18, 24	30	36, 42	48	60
Height "H" inches [mm]	25 [635]	27 [686]	27 [686]	31 [787]	31 [787]
Length "L" inches [mm]	29.75 [756]	29.75 [756]	33.75 [857]	33.75 [857]	35.75 [908]
Width "W" inches [mm]	29.75 [756]	29.75 [756]	33.75 [857]	33.75 [857]	35.75 [908]

RA16	18	24	30	36	42	48	60
Height "H" inches [mm]	27 [686]	27 [686]	27 [686]	31 [787]	39 [991]	45 [1143]	51 [1295]
Length "L" inches [mm]	29.75 [756]	33.75 [857]	35.75 [908]	35.75 [908]	35.75 [908]	35.75 [908]	35.75 [908]
Width "W" inches [mm]	29.75 [756]	29.75 [756]	33.75 [857]	33.75 [857]	35.75 [908]	35.75 [908]	35.75 [908]

Proper Installation

Proper sizing and installation of this equipment is critical to achieve optimal performance. Use the information in this Installation Instruction Manual and reference the applicable manufacturer's specification sheet when installing this product.

IMPORTANT: This product has been designed and manufactured to meet ENERGY STAR criteria for energy efficiency when matched with appropriate indoor components. However, proper refrigerant charge and proper airflow are critical to achieve rated capacity and efficiency. Installation of this product should follow the manufacturer's refrigerant charging and airflow instructions. **Failure to confirm proper charge and airflow may reduce energy efficiency and shorten equipment life.**

MATCH ALL COMPONENTS:

- OUTDOOR UNIT
- INDOOR COIL
- INDOOR AIR HANDLER/FURNACE
- REFRIGERANT LINES
- INDOOR THERMOSTAT

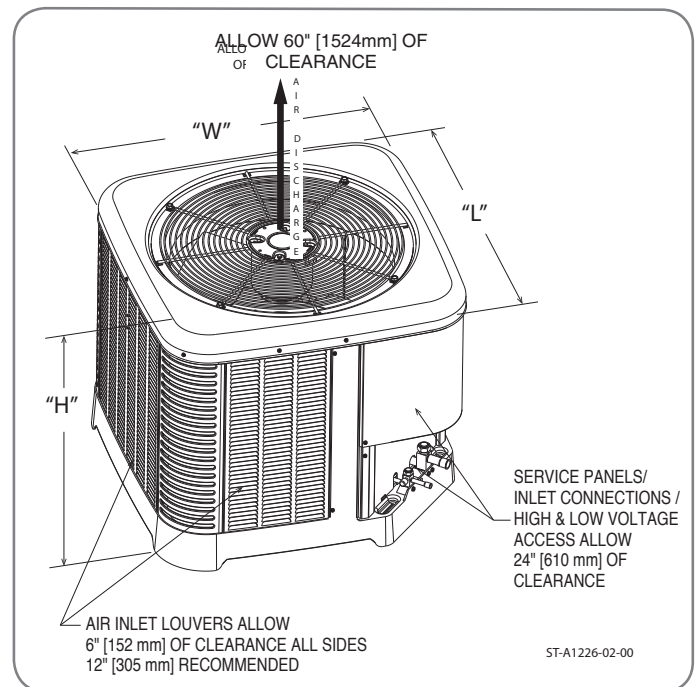

INSTALLATION



Choosing a Location

IMPORTANT: Consult local and national building codes and ordinances for special installation requirements. Following location information will provide longer life and simplified servicing of the outdoor unit.

NOTICE: These units must be installed outdoors. No ductwork can be attached, or other modifications made, to the discharge grille. Modifications will affect performance or operation.

Operational Issues

IMPORTANT: Locate the unit in a manner that will not prevent, impair, or compromise the performance of other equipment installed in proximity to the unit. Maintain all required minimum distances to gas and electric meters, dryer vents, and exhaust and inlet openings. In the absence of national codes or manufacturers' recommendations, local code recommendations and requirements will take precedence.

- Refrigerant piping and wiring should be properly sized and kept as short as possible to avoid capacity losses and increased operating costs.
- Locate the unit where water runoff will not create a problem with the equipment. Position the unit away from the drip edge of the roof whenever possible. Units are weatherized, but can be affected by the following:
 - Water pouring into the unit from the junction of rooflines, without protective guttering. Large volumes of water entering the unit while in operation can impact fan blade or motor life, and coil damage may occur if moisture cannot drain from the unit under freezing conditions.
- Closely follow the clearance recommendations on page 8.
 - 24" [61.0 cm] to the service panel access
 - 60" [152.4 cm] above fan discharge (unit top) to prevent recirculation
 - 6" [15.2 cm] to coil grille air inlets with 12" [30.5 cm] minimum recommended

Corrosive Environment

The metal parts of this unit may be subject to rust or deterioration if exposed to a corrosive environment. This oxidation could shorten the equipment's useful life.

Corrosive elements include, but are not limited to, salt spray, fog or mist in seacoast areas, sulphur or chlorine from lawn watering systems, and various chemical contaminants from industries such as paper mills and petroleum refineries.

If the unit is to be installed in an area where contaminants are likely to be a problem, special attention should be given to the equipment location and exposure.

- Avoid having lawn sprinkler heads spray directly on the unit cabinet.
- In coastal areas, locate the unit on the side of the building away from the waterfront.
- Shielding provided by a fence or shrubs may give some protection, but cannot violate minimum airflow and service access clearances.
- Elevating the unit off its slab or base enough to allow air circulation will help avoid holding water against the base pan.

⚠ WARNING: Disconnect all power to unit before starting maintenance. Failure to do so can cause electrical shock resulting in severe personal injury or death.

Regular maintenance will reduce the buildup of contaminants and help to protect the unit's finish.

- Frequent washing of the cabinet, fan blade, and coil with fresh water will remove most of the salt or other contaminants that build up on the unit.
- Regular cleaning and waxing of the cabinet with a good automobile polish will provide some protection.
- A good liquid cleaner may be used several times a year to remove matter that will not wash off with water.



Choosing a Location (cont.)

For Units With Space Limitations

In the event that a space limitation exists, we will permit the following clearances:

Single-Unit Applications: Side clearances below 6" [15.2 cm] will reduce unit capacity and efficiency. Do not reduce the 60" [152.4 cm] discharge or the 24" [61.0 cm] service clearances.

Multiple-Unit Applications: When multiple condenser grille sides are aligned, a 6" [15.2 cm] per unit side clearance is recommended for a total of 12" [30.5 cm] between two units. Two combined clearances below 12" [30.5 cm] will reduce capacity and efficiency. Do not reduce the 60" [152.4 cm] discharge or 24" [61.0 cm] service clearances.

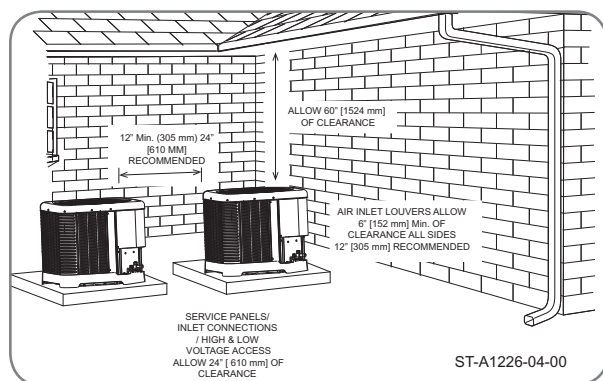

- If installing a unit on a flat roof, use 4" x 4" [10.2 cm x 10.2 cm] or equivalent stringers positioned to distribute unit weight evenly and prevent noise and vibration.

Factory-Preferred Tie-Down Method for High Wind or Seismic Loads

IMPORTANT: The manufacturer-approved/recommended method is a guide to securing equipment for wind and seismic loads. Other methods might provide the same result, but the manufacturer method is the only one endorsed by the manufacturer for securing equipment where wind or earthquake damage can occur. Additional information is available in the PTS (Product Technical Support) section of the manufacturer's Web sites MyRheem.com or MyRuud.com and can be found as a listing under each outdoor model. If you do not have access to this site, your distributor can offer assistance.

Location

Customer Satisfaction Issues

- The unit should be located away from the living, sleeping, and recreational spaces of the owner and those spaces on adjoining property.
- To prevent noise transmission, the mounting pad for the outdoor unit should not be connected to the structure and should be located a sufficient distance above grade to prevent ground water from entering the unit.

Unit Mounting

⚠WARNING: Secure an elevated unit and its elevating stand in order to prevent tipping. Failure to do so may result in severe personal injury or death.

INSTALLATION



Tools and Refrigerant

Tools Required for Installing and Servicing R-410A Models

Manifold Sets:

- Up to 800 PSIG High-Side
- Up to 250 PSIG Low-Side
- 550 PSIG Low-Side Retard

Manifold Hoses:

- Service Pressure Rating of 800 PSIG

Recovery Cylinders:

- 400 PSIG Pressure Rating
- Dept. of Transportation 4BA400 or BW400

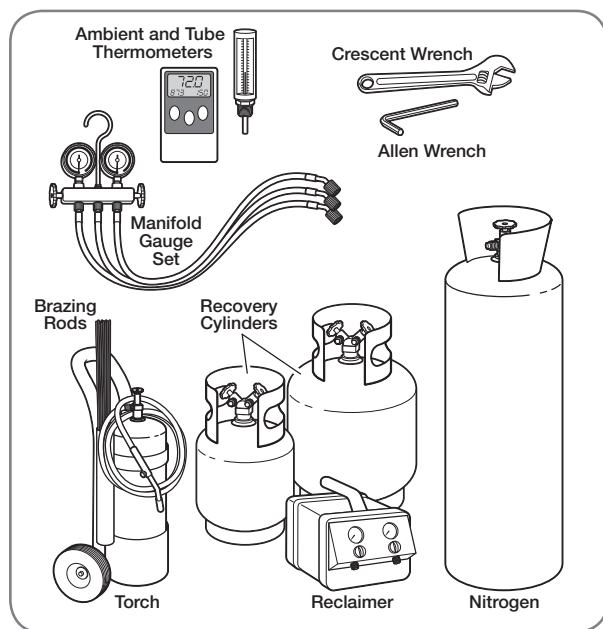

Tools

Pressure: The pressure of R-410A is approximately 60% (1.6 times) greater than R-22. Recovery and recycle equipment, pumps, hoses, and the like must have design pressure ratings appropriate for R-410A. *Manifold sets need to range up to 800 psig high-side and 250 psig low-side with a 550 psig low-side retard. Hoses need to have a service pressure rating of 800 psig. Recovery cylinders need to have a 400 psig service pressure rating, DOT 4BA400 or DOT BW400.*

Combustibility: At pressures above 1 atmosphere, a mixture of R-410A and air can become combustible. **R-410A and air should never be mixed in tanks or supply lines or be allowed to accumulate in storage tanks. Leak checking should never be done with a mixture of R-410A and air.** Leak-checking can be performed safely with nitrogen or a mixture of R-410A and nitrogen.

Quick-Reference Guide For R-410A

- R-410A refrigerant operates at approximately 60% higher pressure (1.6 times) than R-22. Ensure that servicing equipment is designed to operate with R-410A.
- R-410A refrigerant cylinders are light rose in color.
- R-410A, as with other HFCs, is only compatible with POE oils.
- Vacuum pumps will not remove moisture from POE oil used in R-410A systems.
- R-410A systems are to be charged with liquid refrigerants. Prior to March 1999, R-410A refrigerant cylinders had a dip tube. These cylinders should be kept upright for equipment charging. Post-March 1999 cylinders do not have a dip tube and should be inverted to ensure liquid charging of the equipment.
- Do not install a suction line filter drier in the liquid line.
- A factory-approved biflow liquid line filter drier is shipped with every unit and must be installed in the liquid line at the time of installation. Only manufacturer-approved liquid line filter driers can be used. These are Sporlan (CW083S) and Alco (80K083S) driers. These filter driers are rated for minimum working pressure of 600 psig. The filter drier will only have adequate moisture-holding capacity if the system is properly evacuated.
- Desiccant (drying agent) must be compatible for POE oils and R-410A refrigerant.

CAUTION: R-410A systems operate at higher pressures than R-22 systems. Do not use R-22 service equipment or components on R-410A equipment.

Specifications of R-410A

Application: **R-410A is not a drop-in replacement for R-22.** Equipment designs must accommodate its higher pressures. It cannot be retrofitted into R-22 heat pumps.

Physical Properties: R-410A has an atmospheric boiling point of -62.9°F [-52.7°C] and its saturation pressure at 77°F [25°C] is 224.5 psig.

Composition: R-410A is a near-azeotropic mixture of 50% by weight difluoromethane (HFC-32) and 50% by weight pentafluoroethane (HFC-125).



Replacement Units

To prevent failure of a new unit, the existing line set must be correctly sized and cleaned or replaced. Care must be exercised that the expansion device is not plugged. For new and replacement units, a liquid line filter drier must be installed and refrigerant tubing must be properly sized. Test the oil for acid. If positive, a suction line filter drier is mandatory.

IMPORTANT: When replacing an R-22 unit with an R-410A unit, either replace the line set or ensure that residual mineral oil is drained from existing lines, including oil trapped in low spots.



Indoor Coil

CAUTION: Only use evaporators approved for use on R-410A systems that are specifically matched with the outdoor unit per the manufacturer's specification sheets. Use of existing R-22 evaporators can introduce mineral oil to the R-410A refrigerant, forming two different liquids and decreasing oil return to the compressor. This can result in compressor failure.

REFER TO INDOOR COIL MANUFACTURER'S INSTALLATION INSTRUCTIONS.

IMPORTANT: The manufacturer is not responsible for the performance and operation of a mismatched system or for a match listed with another manufacturer's coil.

The thermostatic expansion valve in the matching coil is specifically designed to operate with R-410A. **DO NOT use an R-22 TXV or evaporator. The existing evaporator must be replaced with the factory-specified TXV evaporator specifically designed for R-410A.**

Location

Do not install the indoor coil in the return duct system of a gas or oil furnace. Provide a service inlet to the coil for inspection and cleaning. Keep the coil pitched toward the drain connection.

CAUTION: When coil is installed over a finished ceiling and/or living area, it is required that a secondary condensate pan be installed under entire unit. Failure to do so can result in property damage.



Interconnecting Tubing

The purpose of this section is to specify the best construction/sizing practices for installing interconnection tubing between the indoor and outdoor unit.

Refrigerant Level Adjustment

All units are factory-charged with R-410A refrigerant to cover 15 feet of standard size interconnecting liquid and vapor lines with a required field installed filter drier. Adjustment of charge may be necessary even if the application has exactly 15 feet of line set due to other installation variables such as pressure drop, vertical lift, and indoor coil size. For different lengths, adjust the charge as indicated below. adjust the charge as indicated below.

- 1/4" ± .3 oz./foot [6.4 mm ± 8.5 g/.30 m]
- 5/16" ± .4 oz./foot [7.9 mm ± 11.3 g/.30 m]
- 3/8" ± .6 oz./foot [9.5 mm ± 17.0 g/.30 m]
- 1/2" ± 1.2 oz./foot [12.7 mm ± 34.0 g/.30 m]
- 6 oz. Required factory supplied field installed filter dry

Charge Adjustment = (Line Set (oz. /ft.) x Total Length) – Factory Charge for Line Set

Example: A three ton condensing unit with factory installed 3/8" liquid service valve requires 75 ft of line set with a liquid line diameter of 1/2".

Factory Charge for Line Set = 15ft x .6 oz. = 9 oz.
Charge Adjustment = (1.2 oz. x 75 ft.) – 9 oz. = +81 oz.

INSTALLATION



Interconnecting Tubing (cont.)

Interconnecting Tubing and Fitting Losses

Refrigerant tubing is measured in terms of actual length and equivalent length. Actual length is used for refrigerant charge applications. Equivalent length takes into account pressure losses from

tubing length, fittings, vertical separation, accessories, and filter dryers. The table below references different commonly used equivalent lengths.

Table 1

Equivalent Length for Fittings (ft)							
Line Size (in)	90° Short Radius Elbow	90° Long Radius Elbow	45° Elbow	Solenoid Valve	Check Valve	Site Glass	Filter Dryer
3/8	1.3	0.8	0.3	6	4	0.4	6
1/2	1.4	0.9	0.4	9	5	0.6	6
5/8	1.5	1	0.5	12	6	0.8	6
3/4	1.9	1.3	0.6	14	7	0.9	6
7/8	2.3	1.5	0.7	15	8	1	6
1-1/8	2.7	1.8	0.9	22	12	1.5	6

Liquid Line Selection

The purpose of the liquid line is to transport warm sub-cooled liquid refrigerant from the outdoor unit to the indoor unit. It is important not to allow the refrigerant to flash any superheated vapor prior to the expansion device of the indoor coil. The flashing of refrigerant can occur for the following reasons:

- Low refrigerant charge
- Improperly selected liquid line size
- Absorption of heat prior to expansion device
- Excessive vertical rise between the condenser and evaporator

Table 2 lists the equivalent length per 25' of liquid line at various diameters up to 300'. The total pres-

sure drop allowed for the liquid line is 50 PSI. The procedure for selecting the proper liquid line is as follows:

- Measure the total amount of vertical rise
- Measure the total amount of liquid line needed
- Add all of the equivalent lengths associated with any fittings or accessories using the table above.
- Add the total length and fitting pressure drop. This will equal your total equivalent length.
- Round-down the total equivalent length to the closest value in Table 2.
- Reference Table 2 to verify the round-down value of the calculated equivalent length is compatible with the required vertical rise and diameter of liquid line.

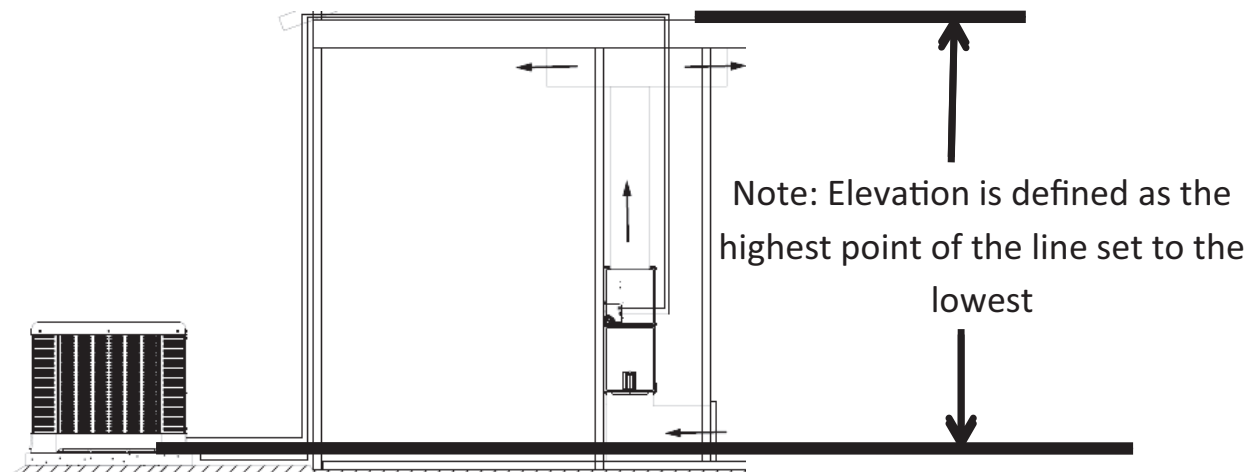

INSTALLATION



Interconnecting Tubing (cont.)

Example: A 3-Ton condensing unit is installed 50' below the ID unit, requires a 75' of 1/2" diameter liquid line, and 4 90° LR elbows.

- Fitting Equivalent Length (ft.) = 4 x .9 = 3.6'
- Total Equivalent Length (ft.) = 75' + 3.6' = 78.6'
- Rounded-down value (ft.) = 75'

R-410A System Capacity Model	Liquid Line Size Connection Size (Inch I.D.) [mm]	Liquid Line Size (Inch O.D.) [mm]	Liquid Line Size Elevation (Above or Below) Indoor Coil												
			Total Equivalent Length - Feet [m]												
			25 [7.62]	50 [15.24]	75 [22.86]	100 [30.48]	125 [45.72]	150 [45.72]	175 [53.34]	200 [60.96]	225 [68.58]	250 [76.20]	275 [83.82]	300 [91.44]	
37	3/8" [9.53]	1/4 [6.35]	25 [7.62]	N/R	N/R	N/R	N/R	N/R	N/R	N/R	N/R	N/R	N/R	N/R	N/R
		5/16 [7.94]	25 [7.62]	50 [15.24]	60 [18.29]	45 [13.72]	35 [10.67]	20 [6.1]	5 [1.52]	N/R	N/R	N/R	N/R	N/R	N/R
		3/8 [9.53]	25 [7.62]	50 [15.24]	75 [22.86]	80 [24.38]	80 [24.38]	75 [22.86]	70 [21.34]	65 [19.81]	60 [18.29]	55 [16.76]	50 [15.24]	45 [13.72]	N/R
		7/16 [11.12]	25 [7.62]	50 [15.24]	75 [22.86]	95 [28.96]	90 [27.43]	90 [27.43]	85 [25.91]	85 [25.91]	85 [25.91]	80 [24.38]	80 [24.38]	80 [24.38]	N/R
		1/2 [12.71]	25 [7.62]	50 [15.24]	75 [22.86]	95 [28.96]	95 [28.96]	95 [28.96]	95 [28.96]	95 [28.96]	95 [28.96]	95 [28.96]	90 [27.43]	90 [27.43]	N/R

(excerpt from Table 2, page 16)

This application is acceptable because the 50' vertical rise is less than the maximum rise of 75' for this application. The application is also considered to have a long line set. Reference the long line set section of the I&O for detail.

Long Line Set Applications

Long line set applications are defined as applications that require accessories or alternate construction methods. The following are special considerations that need to be addressed when installing a long line set application:

- Additional refrigerant charge
- Fitting losses and maximum equivalent length considerations
- Refrigerant migration during the off cycle
- Oil return to the compressor
- Capacity losses
- System oil level adjustment

Table 2 is used to determine if the application is considered to have a long line set. **The region of the chart that is shaded grey is considered to be a long line set application.**

Oil Level Adjustments for Long Line Set Applications

Additional oil will need to be added for long line set applications. (Ref. Table 2). Below is the equation for the oil level adjustment and the compressor name plate oil charge for the different od units.

$$\text{Oil to be Added} = [(\text{Charge Adjustment} + \text{OD Unit Name Plate Charge (oz.)}) \times (0.022)] - [(0.10) \times (\text{Compressor Name Plate Oil Charge (oz.)})]$$

Example: An application requires 125ft of line set with a liquid line diameter of 3/8", Charge Adjustment = 52.4 oz., Name Plate Charge = 107 oz., Name Plate Oil Charge = 25 oz., Oil to be Added = (52.4 oz. + 107 oz.) x .022 - (.10 x 25 oz.) = 1.0 oz.

RA13 OD Model	Compressor	Name Plate Oil Charge (oz)	Factory Installed CCH
RA1318AJ	ZP14KAE-PFV-130	21	N
RA1318AJ Alternate	ZP14K6E-PFC-130	21	N
RA1324AJ	ZP20KAE-PFV-130	21	N
RA1330AJ	ZP24K5E-PFV-130	25	N
RA1336AJ	ZP31K6E-PFV-130	25	N
RA1342AJ	ZP34K5E-PFV-130	42	N
RA1348AJ	ZP42K5E-PFV-130	42	N
RA1360AJ	ZP51K5E-PFV-130	42	N
RA1336AC	ZP31K6E-TF5-130	25	N
RA1342AC	ZP34K5E-TF5-130	42	N
RA1348AC	ZP42K5E-TF5-130	42	N
RA1360AC	ZP51K5E-TF5-130	42	N
RA1336AD	ZP31K6E-TFD-130	25	N
RA1342AD	ZP34K5E-TFD-130	42	N
RA1348AD	ZP42K5E-TFD-130	42	N
RA1360AD	ZP51K5E-TFD-130	42	N
RA1348AY	ZP42K5E-TFE-130	42	N
RA1360AY	ZP51K5E-TFE-130	42	N

RA14 OD Model	Compressor	Name Plate Oil Charge (oz)	Factory Installed CCH
RA1418AJ	ZP14KAE-PFV-130	21	N
RA1418AJ Alternate	ZP14K6E-PFC-130	21	N
RA1424AJ	ZP20KAE-PFV-130	21	N
RA1430AJ	ZP24K5E-PFV-130	25	N
RA1436AJ	ZP29K5E-PFV-130	25	N
RA1442AJ	ZP34K5E-PFV-130	42	N
RA1448AJ	ZP39K5E-PFV-130	42	N
RA1460AJ	ZP49K6E-PFV-130	42	N
RA1436AC	ZP31K6E-TF5-130	25	N
RA1442AC	ZP34K5E-TF5-130	42	N
RA1448AC	ZP42K5E-TF5-130	42	N
RA1460AC	ZP51K5E-TF5-130	42	Y
RA1436AD	ZP31K6E-TFD-130	25	N
RA1442AD	ZP34K5E-TFD-130	42	N
RA1448AY	ZP42K5E-TFD-130	42	N
RA1460AY	ZP51K5E-TFD-130	42	Y

INSTALLATION



Interconnecting Tubing (cont.)

RA16 OD Model	Compressor	Name Plate Oil Charge (oz)	Factory Installed CCH
RA1618AJ	ZP14K6E-PFV-130	21	N
RA1624AJ	ZP21K6E-PFV-130	21	N
RA1630AJ	ZP24K6E-PFV-130	25	N
RA1636AJ	ZP31K6E-PFV-130	25	N
RA1642AJ	ZP34K6E-PFV-130	42	N
RA1648AJ	ZP38K6E-PFV-130	42	N
RA1660AJ	ZP49K6E-PFV-130	42	Y
RA1660BJ	ZP49K6E-PFV-130	42	Y
RA1636AC	ZP31K6E-TF5-130	42	N
RA1642AC	ZP34K6E-TF5-130	42	N
RA1648AC	ZP38K6E-TF5-130	42	Y
RA1660AC	ZP49K6E-TF5-130	42	Y

Suction Line Selection

Purpose of the suction line is to return superheated vapor to the condensing unit from the evaporator. Proper suction line sizing is important because it plays an important role in returning oil to the compressor to prevent potential damage to the bearings, valves, and scroll sets. Also, an improperly sized suction line can dramatically reduce capacity and performance of the system. The procedure for selecting the proper suction line is as follows:

- The total amount of suction line needed
- Add all of the equivalent lengths associated with any fittings or accessories using the table on previous page.
- Add the total length and fitting pressure drop. This will equal your total equivalent length.
- Reference Table 2 to verify that the calculated equivalent length falls within the compatibility region of the chart.
- Verify Table 3 to verify the capacity difference is compatible with the application.

Refrigerant Migration During Off Cycle

Long line set applications can require a considerable amount of additional refrigerant. This additional refrigerant needs to be managed throughout the entire ambient operating envelope that the system will go through during its life cycle. Off-Cycle migration is where excess refrigerant condenses and migrates to the lowest part of the system. Excessive build-up of refrigerant at the compressor will result in poor reliability and noisy operation during startup. This section demonstrates the required accessories and unit configuration for different applications.

OUTDOOR UNIT LEVEL OR NEAR LEVEL TO INDOOR SECTION LINE SET

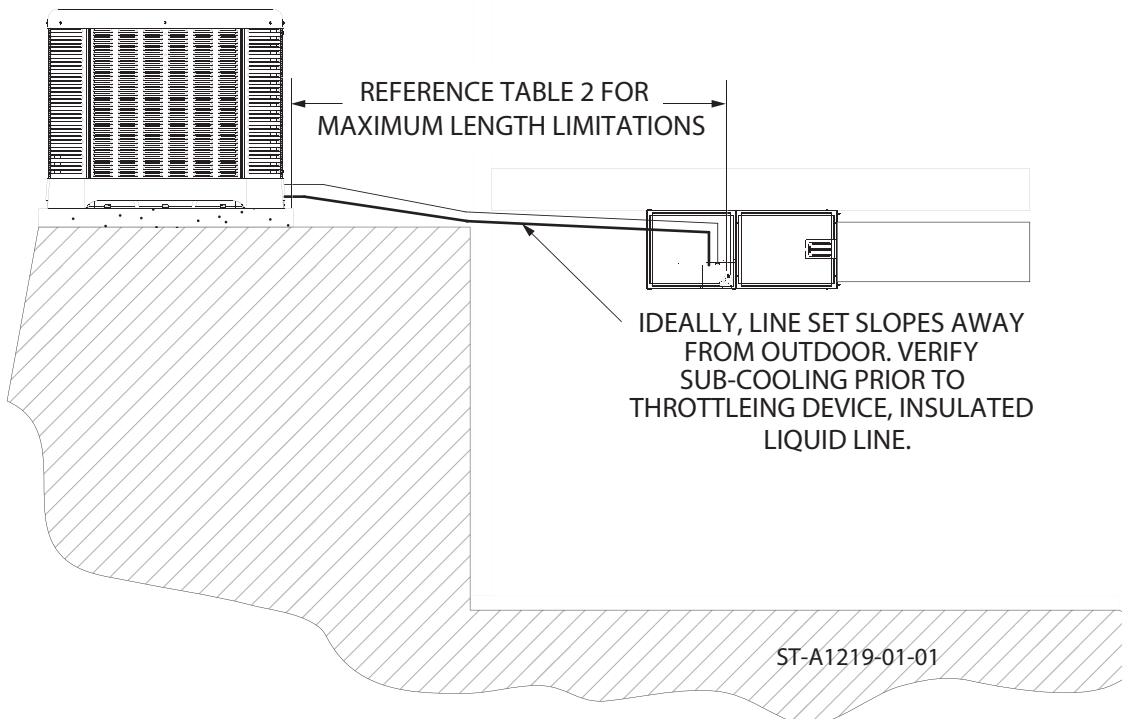



Interconnecting Tubing (cont.)

For applications that are considered to have a long line set with the outdoor unit and indoor unit on the same level the following is required:

- TXV or EEV on the indoor unit
- Start components may be required depending upon quality of voltage (consistently <200vac at outdoor unit)
- Crankcase heater (Some models have factory installed CCH's. Refer to tables on pages 13 and 14.)

- Insulated liquid and suction line
- Vapor line should slope toward the indoor unit
- Follow the proper line sizing, equivalent length, charging requirements, and oil level adjustments spelled out in this document and the outdoor units I&O
- Verify at least 5°F sub-cooling at the ID unit prior to throttling device

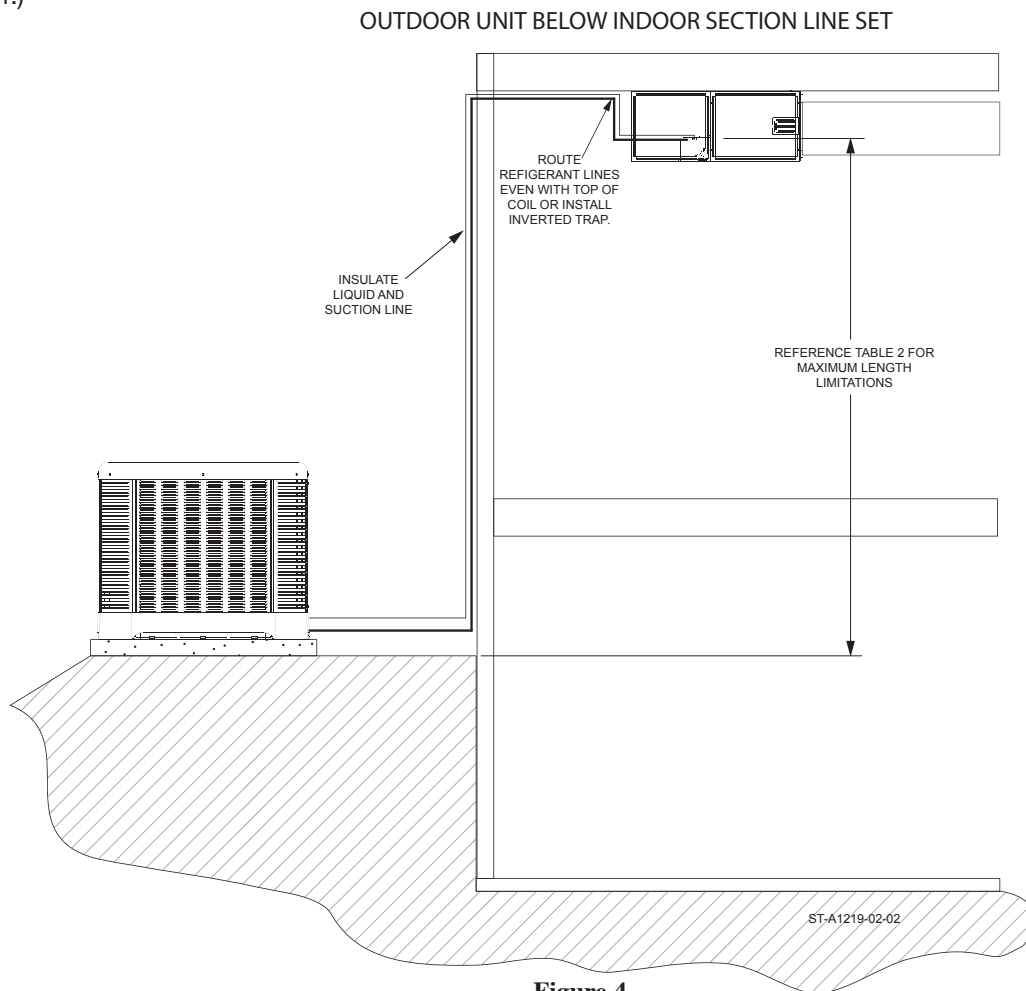

Figure 4

For applications that are considered to have a long line set with the outdoor unit below the indoor unit the following is required:

- TXV or EEV at the IDunit
- Crankcase heater (Some models come with factory installed CCH's. Refer to tables on page 13 & 14.)
- Start components may be required depending upon quality of voltage (consistently <200vac at outdoor unit)
- Refrigerant lines should be routed even with the top of the ID coil or an inverted trap is to be ap-

plied. (Reference figure 4).

- Insulated liquid and suction line
- Follow the proper line sizing, equivalent length, charging requirements, and oil level adjustments spelled out in this document and the outdoor units I&O
- Measure pressure at the liquid line service valve and prior to expansion device. Verify that it is not greater than 50 PSI
- For elevations greater than 25' can expect a lower sub-cooling

INSTALLATION



Interconnecting Tubing (cont.)

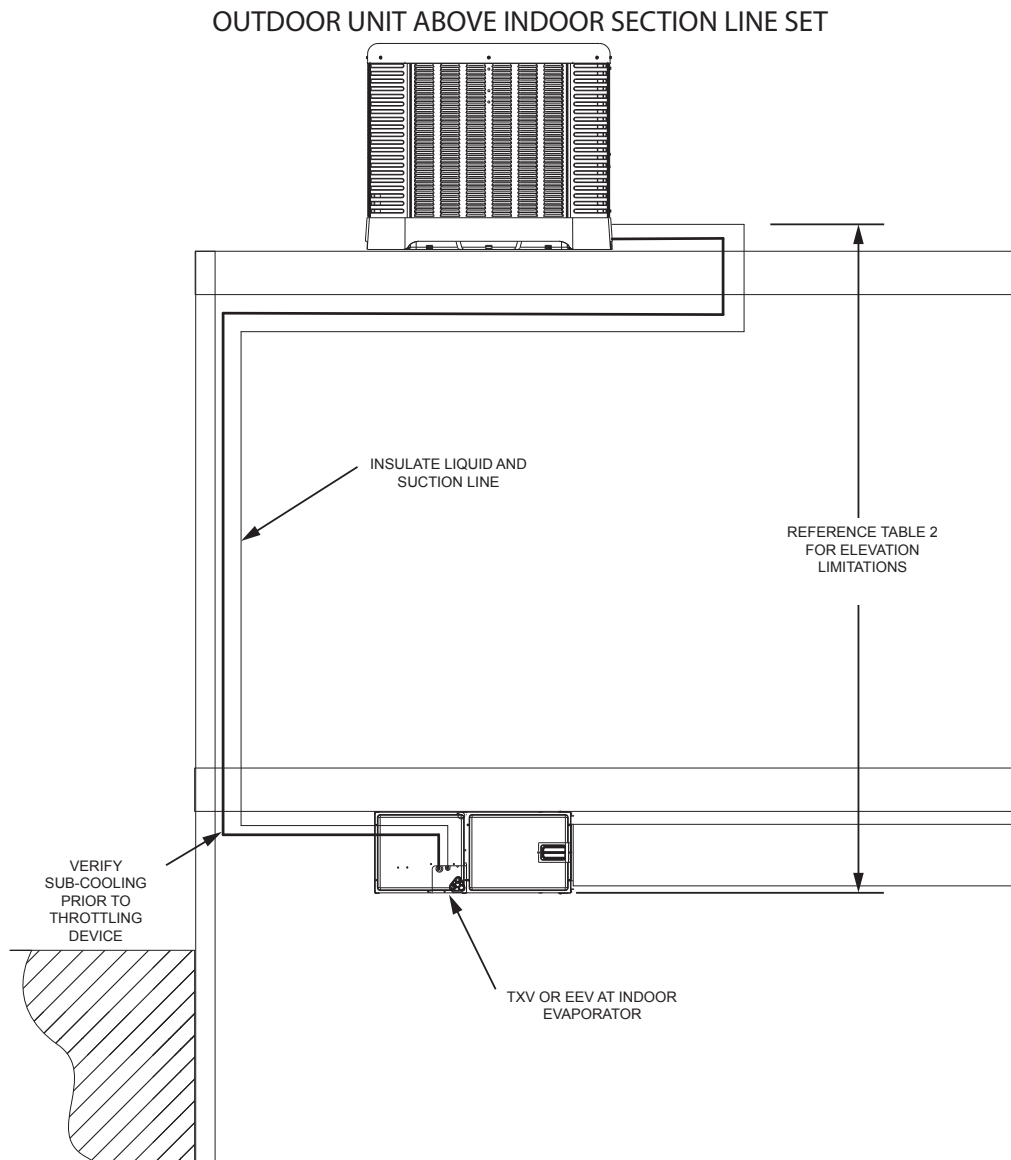

Tubing

For applications that are considered to have a long line set with the outdoor unit above the indoor unit the following is required:

- TXV at the indoor unit
- Crankcase heater (some models have factory installed CCH's. Refer to tables on pages 13 & 14).
- Start components maybe required depending upon quality of voltage (consistently <200vac at outdoor unit)
- Insulated liquid and suction line
- Follow the proper line sizing, equivalent length, charging requirements, and oil level adjustments spelled out in this document and the outdoor units I&O
- Verify at least 5°F sub-cooling at the ID unit prior to throttling device

INSTALLATION

Interconnecting Tubing (cont.)

R413 System Capacity Model	Vapor Line Connection Size (Inch I.D.) [mm]	Vapor Line Size (Inch O.D.) [mm]	Vapor Line Selection Chart Capacity Multiplier Table															
			Total Equivalent Length - Feet (m)															
			25 [7.62]	50 [15.24]	75 [22.86]	100 [30.48]	125 [45.72]	150 [45.72]	175 [53.34]	200 [60.96]	225 [68.58]	250 [76.20]	275 [83.82]	300 [91.44]				
18	3/4" [19.06]	5/8 [15.88] 3/4 [19.05] 7/8 [22.23] 1 [25.4]	1.00	0.99	0.98	0.98	0.98	0.98	0.97	0.97	0.97	0.96	0.96	0.96	0.96	0.95		
			1.00	1.00	1.00	1.00	1.00	0.99	0.99	0.99	0.99	0.99	0.99	0.99	0.99	0.99		
			N/R	N/R	N/R	N/R	N/R	N/R	N/R	N/R	N/R	N/R	N/R	N/R	N/R	N/R		
24	3/4" [19.06]	5/8 [15.88] 3/4 [19.05] 7/8 [22.23] 1 [25.4]	1.00	0.99	0.98	0.98	0.98	0.98	0.97	0.97	0.97	0.96	0.96	0.96	0.95			
			1.00	1.00	1.00	1.00	1.00	0.99	0.99	0.99	0.99	0.99	0.99	0.99	0.99			
			N/R	N/R	N/R	N/R	N/R	N/R	N/R	N/R	N/R	N/R	N/R	N/R	N/R			
30	3/4" [19.06]	5/8 [15.88] 3/4 [19.05] 7/8 [22.23] 1 [25.4]	1.00	0.99	0.98	0.98	0.98	0.98	0.97	0.97	0.97	0.96	0.96	0.96	0.95			
			1.00	1.00	1.00	1.00	1.00	0.99	0.99	0.99	0.99	0.99	0.99	0.99	0.99			
			N/R	N/R	N/R	N/R	N/R	N/R	N/R	N/R	N/R	N/R	N/R	N/R	N/R			
36	3/4" [19.06]	5/8 [15.88] 3/4 [19.05] 7/8 [22.23] 1 [25.4]	1.00	0.99	0.98	0.98	0.98	0.98	0.97	0.97	0.97	0.96	0.96	0.96	0.95			
			1.00	1.00	1.00	1.00	1.00	0.99	0.99	0.99	0.99	0.99	0.99	0.99	0.99			
			N/R	N/R	N/R	N/R	N/R	N/R	N/R	N/R	N/R	N/R	N/R	N/R	N/R			
42	7/8" [22.22]	1 [25.4]	1.00	1.00	1.00	1.00	1.00	1.00	1.00	1.00	1.00	1.00	1.00	1.00	1.01			
			1.00	1.00	1.00	1.00	1.00	0.99	0.99	0.99	0.99	0.99	0.99	0.99	0.99			
			N/R	N/R	N/R	N/R	N/R	N/R	N/R	N/R	N/R	N/R	N/R	N/R	N/R			
48	7/8" [22.22]	1 [25.4]	1.00	0.99	0.98	0.98	0.98	0.98	0.97	0.97	0.97	0.96	0.96	0.96	0.95			
			1.00	1.00	1.00	1.00	1.00	0.99	0.99	0.99	0.99	0.99	0.99	0.99	0.99			
			N/R	N/R	N/R	N/R	N/R	N/R	N/R	N/R	N/R	N/R	N/R	N/R	N/R			
60	7/8" [22.22]	1 [25.4]	1.00	0.99	0.98	0.98	0.98	0.98	0.97	0.97	0.97	0.96	0.96	0.96	0.95			
			1.00	1.00	1.00	1.00	1.00	0.99	0.99	0.99	0.99	0.99	0.99	0.99	0.99			
			N/R	N/R	N/R	N/R	N/R	N/R	N/R	N/R	N/R	N/R	N/R	N/R	N/R			

NOTES:
 N/R = Application not recommended.
 All calculations assume a 3/8" liquid line

INSTALLATION

Interconnecting Tubing (cont.)

RA14 R-410A System Capacity Model	Vapor Line Connection Size (Inch I.D.) [mm]	Vapor Line Size (Inch O.D.) [mm]	Suction Line Size Outdoor unit Above or Below Indoor Coil																					
			Total Equivalent Length - Feet [m]																					
			25 [7.62]	50 [15.24]	75 [22.86]	100 [30.48]	125 [45.72]	150 [45.72]	175 [53.34]	200 [60.96]	225 [68.59]	250 [76.20]	275 [83.82]	300 [91.44]										
18	3/4" [19.06]	5/8 [15.88] 3/4 [19.05] 7/8 [22.23] 1 [25.4] 1-1/8 [28.58]	1.00	0.99	0.99	1.00	0.98	0.98	0.98	0.99	0.97	0.97	0.99	0.96	0.96	0.99	0.96							
			N/R	N/R	N/R	N/R	N/R	N/R	N/R	N/R	N/R	N/R	N/R	N/R	N/R	N/R	N/R							
			N/R	N/R	N/R	N/R	N/R	N/R	N/R	N/R	N/R	N/R	N/R	N/R	N/R	N/R	N/R	N/R						
			N/R	N/R	N/R	N/R	N/R	N/R	N/R	N/R	N/R	N/R	N/R	N/R	N/R	N/R	N/R	N/R						
			N/R	N/R	N/R	N/R	N/R	N/R	N/R	N/R	N/R	N/R	N/R	N/R	N/R	N/R	N/R	N/R						
			N/R	N/R	N/R	N/R	N/R	N/R	N/R	N/R	N/R	N/R	N/R	N/R	N/R	N/R	N/R	N/R	N/R					
24	3/4" [19.06]	5/8 [15.88] 3/4 [19.05] 7/8 [22.23] 1 [25.4] 1-1/8 [28.58]	1.00	0.98	0.97	0.97	0.97	0.95	0.95	0.95	0.94	0.93	0.93	0.93	0.92	0.92	0.91							
			N/R	N/R	N/R	N/R	N/R	N/R	N/R	N/R	N/R	N/R	N/R	N/R	N/R	N/R	N/R	N/R						
			N/R	N/R	N/R	N/R	N/R	N/R	N/R	N/R	N/R	N/R	N/R	N/R	N/R	N/R	N/R	N/R	N/R					
			N/R	N/R	N/R	N/R	N/R	N/R	N/R	N/R	N/R	N/R	N/R	N/R	N/R	N/R	N/R	N/R	N/R					
			N/R	N/R	N/R	N/R	N/R	N/R	N/R	N/R	N/R	N/R	N/R	N/R	N/R	N/R	N/R	N/R	N/R	N/R				
			N/R	N/R	N/R	N/R	N/R	N/R	N/R	N/R	N/R	N/R	N/R	N/R	N/R	N/R	N/R	N/R	N/R	N/R				
30	3/4" [19.06]	5/8 [15.88] 3/4 [19.05] 7/8 [22.23] 1 [25.4] 1-1/8 [28.58]	0.99	0.98	0.97	0.96	0.96	0.95	0.93	0.93	0.93	0.91	0.9	0.89	0.87	0.85	0.85	0.84						
			N/R	N/R	N/R	N/R	N/R	N/R	N/R	N/R	N/R	N/R	N/R	N/R	N/R	N/R	N/R	N/R	N/R					
			N/R	N/R	N/R	N/R	N/R	N/R	N/R	N/R	N/R	N/R	N/R	N/R	N/R	N/R	N/R	N/R	N/R	N/R				
			N/R	N/R	N/R	N/R	N/R	N/R	N/R	N/R	N/R	N/R	N/R	N/R	N/R	N/R	N/R	N/R	N/R	N/R				
			N/R	N/R	N/R	N/R	N/R	N/R	N/R	N/R	N/R	N/R	N/R	N/R	N/R	N/R	N/R	N/R	N/R	N/R	N/R			
			N/R	N/R	N/R	N/R	N/R	N/R	N/R	N/R	N/R	N/R	N/R	N/R	N/R	N/R	N/R	N/R	N/R	N/R	N/R			
36	3/4" [19.06]	5/8 [15.88] 3/4 [19.05] 7/8 [22.23] 1 [25.4] 1-1/8 [28.58]	1.00	1.00	1.00	0.99	0.99	0.98	0.99	0.99	0.99	0.97	0.99	0.98	0.97	0.96	0.96	0.96	0.96					
			N/R	N/R	N/R	N/R	N/R	N/R	N/R	N/R	N/R	N/R	N/R	N/R	N/R	N/R	N/R	N/R	N/R	N/R				
			N/R	N/R	N/R	N/R	N/R	N/R	N/R	N/R	N/R	N/R	N/R	N/R	N/R	N/R	N/R	N/R	N/R	N/R	N/R			
			N/R	N/R	N/R	N/R	N/R	N/R	N/R	N/R	N/R	N/R	N/R	N/R	N/R	N/R	N/R	N/R	N/R	N/R	N/R			
			N/R	N/R	N/R	N/R	N/R	N/R	N/R	N/R	N/R	N/R	N/R	N/R	N/R	N/R	N/R	N/R	N/R	N/R	N/R	N/R		
			N/R	N/R	N/R	N/R	N/R	N/R	N/R	N/R	N/R	N/R	N/R	N/R	N/R	N/R	N/R	N/R	N/R	N/R	N/R	N/R		
42	7/8" [22.22]	5/8 [15.88] 3/4 [19.05] 7/8 [22.23] 1 [25.4] 1-1/8 [28.58]	0.98	0.95	0.93	0.92	0.92	0.9	0.88	0.88	0.86	0.85	0.85	0.84	0.82	0.82	0.82	0.82	0.82	0.82				
			N/R	N/R	N/R	N/R	N/R	N/R	N/R	N/R	N/R	N/R	N/R	N/R	N/R	N/R	N/R	N/R	N/R	N/R	N/R			
			N/R	N/R	N/R	N/R	N/R	N/R	N/R	N/R	N/R	N/R	N/R	N/R	N/R	N/R	N/R	N/R	N/R	N/R	N/R	N/R		
			N/R	N/R	N/R	N/R	N/R	N/R	N/R	N/R	N/R	N/R	N/R	N/R	N/R	N/R	N/R	N/R	N/R	N/R	N/R	N/R		
			N/R	N/R	N/R	N/R	N/R	N/R	N/R	N/R	N/R	N/R	N/R	N/R	N/R	N/R	N/R	N/R	N/R	N/R	N/R	N/R	N/R	
			N/R	N/R	N/R	N/R	N/R	N/R	N/R	N/R	N/R	N/R	N/R	N/R	N/R	N/R	N/R	N/R	N/R	N/R	N/R	N/R	N/R	
48	7/8" [22.22]	5/8 [15.88] 3/4 [19.05] 7/8 [22.23] 1 [25.4] 1-1/8 [28.58]	0.97	0.94	0.91	0.98	0.87	0.87	0.86	0.85	0.85	0.85	0.84	0.84	0.82	0.82	0.82	0.82	0.82	0.82	0.82			
			N/R	N/R	N/R	N/R	N/R	N/R	N/R	N/R	N/R	N/R	N/R	N/R	N/R	N/R	N/R	N/R	N/R	N/R	N/R	N/R		
			N/R	N/R	N/R	N/R	N/R	N/R	N/R	N/R	N/R	N/R	N/R	N/R	N/R	N/R	N/R	N/R	N/R	N/R	N/R	N/R	N/R	
			N/R	N/R	N/R	N/R	N/R	N/R	N/R	N/R	N/R	N/R	N/R	N/R	N/R	N/R	N/R	N/R	N/R	N/R	N/R	N/R	N/R	
			N/R	N/R	N/R	N/R	N/R	N/R	N/R	N/R	N/R	N/R	N/R	N/R	N/R	N/R	N/R	N/R	N/R	N/R	N/R	N/R	N/R	
			N/R	N/R	N/R	N/R	N/R	N/R	N/R	N/R	N/R	N/R	N/R	N/R	N/R	N/R	N/R	N/R	N/R	N/R	N/R	N/R	N/R	N/R
60	7/8" [22.22]	5/8 [15.88] 3/4 [19.05] 7/8 [22.23] 1 [25.4] 1-1/8 [28.58]	0.99	0.98	0.96	0.95	0.95	0.94	0.94	0.93	0.93	0.93	0.93	0.92	0.92	0.92	0.92	0.92	0.92	0.92	0.92			
			N/R	N/R	N/R	N/R	N/R	N/R	N/R	N/R	N/R	N/R	N/R	N/R	N/R	N/R	N/R	N/R	N/R	N/R	N/R	N/R		
			N/R	N/R	N/R	N/R	N/R	N/R	N/R	N/R	N/R	N/R	N/R	N/R	N/R	N/R	N/R	N/R	N/R	N/R	N/R	N/R	N/R	
			N/R	N/R	N/R	N/R	N/R	N/R	N/R	N/R	N/R	N/R	N/R	N/R	N/R	N/R	N/R	N/R	N/R	N/R	N/R	N/R	N/R	
			N/R	N/R	N/R	N/R	N/R	N/R	N/R	N/R	N/R	N/R	N/R	N/R	N/R	N/R	N/R	N/R	N/R	N/R	N/R	N/R	N/R	N/R
			N/R	N/R	N/R	N/R	N/R	N/R	N/R	N/R	N/R	N/R	N/R	N/R	N/R	N/R	N/R	N/R	N/R	N/R	N/R	N/R	N/R	N/R

NOTES:
N/R = Application not recommended.

Table 3 cont.

INSTALLATION

Interconnecting Tubing (cont.)

R410a System Capacity Model	Vapor Line Connection Size (Inch I.D.) [mm]	Vapor Line Size (Inch O.D.) [mm]	Vapor Line Selection Chart Capacity Multiplier Table																	
			Total Equivalent Length - Feet (m)																	
			25 [7.62]	50 [15.24]	75 [22.86]	100 [30.48]	125 [45.72]	150 [45.72]	175 [53.34]	200 [60.96]	225 [68.58]	250 [76.20]	275 [83.82]	300 [91.44]						
18	3/4" [19.06]	5/8 [15.88] 3/4 [19.05] 7/8 [22.23] 1 [25.4]	1.00	0.99	0.99	0.99	0.98	0.98	0.97	0.97	0.97	0.97	0.97	0.97	0.96	0.96	0.96	0.96	0.96	
			1.00	1.00	1.00	1.00	1.00	1.00	1.00	1.00	1.00	1.00	1.00	1.00	1.00	1.00	1.00	1.00	1.00	1.00
			N/R	N/R	N/R	N/R	N/R	N/R	N/R	N/R	N/R	N/R	N/R	N/R	N/R	N/R	N/R	N/R	N/R	N/R
			N/R	N/R	N/R	N/R	N/R	N/R	N/R	N/R	N/R	N/R	N/R	N/R	N/R	N/R	N/R	N/R	N/R	N/R
			N/R	N/R	N/R	N/R	N/R	N/R	N/R	N/R	N/R	N/R	N/R	N/R	N/R	N/R	N/R	N/R	N/R	N/R
			N/R	N/R	N/R	N/R	N/R	N/R	N/R	N/R	N/R	N/R	N/R	N/R	N/R	N/R	N/R	N/R	N/R	N/R
24	3/4" [19.06]	5/8 [15.88] 3/4 [19.05] 7/8 [22.23] 1 [25.4]	1.01	0.99	0.98	0.97	0.96	0.95	0.95	0.94	0.94	0.94	0.93	0.91	0.91	0.91	0.91	0.91	0.91	
			1.00	1.00	1.01	1.00	1.00	1.00	1.00	1.00	1.00	1.00	1.00	1.00	1.00	1.00	1.00	1.00	1.00	1.00
			N/R	N/R	N/R	N/R	N/R	N/R	N/R	N/R	N/R	N/R	N/R	N/R	N/R	N/R	N/R	N/R	N/R	N/R
			N/R	N/R	N/R	N/R	N/R	N/R	N/R	N/R	N/R	N/R	N/R	N/R	N/R	N/R	N/R	N/R	N/R	N/R
			N/R	N/R	N/R	N/R	N/R	N/R	N/R	N/R	N/R	N/R	N/R	N/R	N/R	N/R	N/R	N/R	N/R	N/R
			N/R	N/R	N/R	N/R	N/R	N/R	N/R	N/R	N/R	N/R	N/R	N/R	N/R	N/R	N/R	N/R	N/R	N/R
30	3/4" [19.06]	5/8 [15.88] 3/4 [19.05] 7/8 [22.23] 1 [25.4]	1.01	0.99	0.98	0.97	0.96	0.93	0.93	0.91	0.91	0.91	0.91	0.91	0.89	0.89	0.87	0.87	0.86	
			1.00	1.00	1.00	1.00	1.00	1.00	1.00	1.00	1.00	1.00	1.00	1.00	1.00	1.00	1.00	1.00	1.00	1.00
			N/R	N/R	N/R	N/R	N/R	N/R	N/R	N/R	N/R	N/R	N/R	N/R	N/R	N/R	N/R	N/R	N/R	N/R
			N/R	N/R	N/R	N/R	N/R	N/R	N/R	N/R	N/R	N/R	N/R	N/R	N/R	N/R	N/R	N/R	N/R	N/R
			N/R	N/R	N/R	N/R	N/R	N/R	N/R	N/R	N/R	N/R	N/R	N/R	N/R	N/R	N/R	N/R	N/R	N/R
			N/R	N/R	N/R	N/R	N/R	N/R	N/R	N/R	N/R	N/R	N/R	N/R	N/R	N/R	N/R	N/R	N/R	N/R
36	3/4" [19.06]	5/8 [15.88] 3/4 [19.05] 7/8 [22.23] 1 [25.4]	1.01	1.00	1.00	1.00	1.00	1.00	1.00	1.00	1.00	1.00	1.00	1.00	1.00	1.00	1.00	1.00	1.00	
			1.01	1.00	1.00	1.00	1.00	1.00	1.00	1.00	1.00	1.00	1.00	1.00	1.00	1.00	1.00	1.00	1.00	1.00
			N/R	N/R	N/R	N/R	N/R	N/R	N/R	N/R	N/R	N/R	N/R	N/R	N/R	N/R	N/R	N/R	N/R	N/R
			N/R	N/R	N/R	N/R	N/R	N/R	N/R	N/R	N/R	N/R	N/R	N/R	N/R	N/R	N/R	N/R	N/R	N/R
			N/R	N/R	N/R	N/R	N/R	N/R	N/R	N/R	N/R	N/R	N/R	N/R	N/R	N/R	N/R	N/R	N/R	N/R
			N/R	N/R	N/R	N/R	N/R	N/R	N/R	N/R	N/R	N/R	N/R	N/R	N/R	N/R	N/R	N/R	N/R	N/R
42	7/8" [22.22]	5/8 [15.88] 3/4 [19.05] 7/8 [22.23] 1 [25.4]	0.98	0.97	0.94	0.92	0.91	0.89	0.87	0.86	0.84	0.84	0.83	0.82	0.82	0.81	0.81	0.81	0.81	
			1.00	1.00	0.99	0.99	0.98	0.98	0.98	0.98	0.98	0.98	0.98	0.98	0.98	0.98	0.98	0.98	0.98	0.98
			N/R	N/R	N/R	N/R	N/R	N/R	N/R	N/R	N/R	N/R	N/R	N/R	N/R	N/R	N/R	N/R	N/R	N/R
			N/R	N/R	N/R	N/R	N/R	N/R	N/R	N/R	N/R	N/R	N/R	N/R	N/R	N/R	N/R	N/R	N/R	N/R
			N/R	N/R	N/R	N/R	N/R	N/R	N/R	N/R	N/R	N/R	N/R	N/R	N/R	N/R	N/R	N/R	N/R	N/R
			N/R	N/R	N/R	N/R	N/R	N/R	N/R	N/R	N/R	N/R	N/R	N/R	N/R	N/R	N/R	N/R	N/R	N/R
48	7/8" [22.22]	5/8 [15.88] 3/4 [19.05] 7/8 [22.23] 1 [25.4]	0.98	0.95	0.92	0.88	0.88	0.86	0.85	0.82	0.82	0.82	0.82	0.82	0.82	0.82	0.82	0.82	0.82	
			1.00	0.99	0.98	0.97	0.97	0.96	0.96	0.96	0.94	0.94	0.94	0.94	0.94	0.94	0.94	0.94	0.94	0.94
			N/R	N/R	N/R	N/R	N/R	N/R	N/R	N/R	N/R	N/R	N/R	N/R	N/R	N/R	N/R	N/R	N/R	N/R
			N/R	N/R	N/R	N/R	N/R	N/R	N/R	N/R	N/R	N/R	N/R	N/R	N/R	N/R	N/R	N/R	N/R	N/R
			N/R	N/R	N/R	N/R	N/R	N/R	N/R	N/R	N/R	N/R	N/R	N/R	N/R	N/R	N/R	N/R	N/R	N/R
			N/R	N/R	N/R	N/R	N/R	N/R	N/R	N/R	N/R	N/R	N/R	N/R	N/R	N/R	N/R	N/R	N/R	N/R
60	7/8" [22.22]	5/8 [15.88] 3/4 [19.05] 7/8 [22.23] 1 [25.4]	1.02	1.01	1.01	1.00	1.00	1.00	1.00	1.00	1.00	1.00	1.00	1.00	1.00	1.00	1.00	1.00	1.00	
			1.02	1.01	1.01	1.00	1.00	1.00	1.00	1.00	1.00	1.00	1.00	1.00	1.00	1.00	1.00	1.00	1.00	1.00
			N/R	N/R	N/R	N/R	N/R	N/R	N/R	N/R	N/R	N/R	N/R	N/R	N/R	N/R	N/R	N/R	N/R	N/R
			N/R	N/R	N/R	N/R	N/R	N/R	N/R	N/R	N/R	N/R	N/R	N/R	N/R	N/R	N/R	N/R	N/R	N/R
			N/R	N/R	N/R	N/R	N/R	N/R	N/R	N/R	N/R	N/R	N/R	N/R	N/R	N/R	N/R	N/R	N/R	N/R
			N/R	N/R	N/R	N/R	N/R	N/R	N/R	N/R	N/R	N/R	N/R	N/R	N/R	N/R	N/R	N/R	N/R	N/R

NOTES:
 N/R = Application not recommended.
 All calculations assume a 3/8" liquid line



Interconnecting Tubing (cont.)

Tubing Installation

Observe the following when installing correctly sized type “L” refrigerant tubing between the condensing unit and evaporator coil:

- Check the tables on pages 16 & 17 for the correct suction line size and liquid line size.
- If a portion of the liquid line passes through a very hot area where liquid refrigerant can be heated to form vapor, insulating the liquid line is required.
- Use clean, dehydrated, sealed refrigeration-grade tubing.
- Always keep tubing sealed until tubing is in place and connections are to be made.
- A high-quality filter drier is included with all R-410A units and must be installed in the liquid line upon unit installation.
- When replacing an R-22 system with an R-410A system and the line set is not replaced, drain any oil that has pooled in low spots in the lineset. Commercially available flush kits are not recommended due to the risk of residual flushing agent being incompatible with POE oils or internal components. Up to 5% mineral oil is considered acceptable in R-410A systems.
- If tubing has been cut, make sure ends are deburred while holding in a position to prevent chips from falling into tubing. Burrs such as those caused by tubing cutters can affect performance dramatically, particularly on small liquid line sizes.
- For best operation, keep tubing run as short as possible with a minimum number of elbows or bends.
- Locations where the tubing will be exposed to mechanical damage should be avoided. If it is necessary to use such locations, the copper tubing should be housed to prevent damage.

INSTALLATION



Interconnecting Tubing (cont.)

- If tubing is to be run underground, it must be run in a sealed watertight chase.
- Use care in routing tubing and do not kink or twist. Use a good tubing bender on the vapor line to prevent kinking.

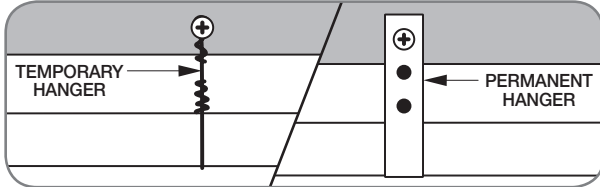

- Route the tubing using temporary hangers; then straighten the tubing and install permanent hangers. Line must be adequately supported.
- If the vapor line comes in contact with inside walls, ceiling, or flooring, the vibration of the vapor line in the heating mode will result in noise inside the structure.

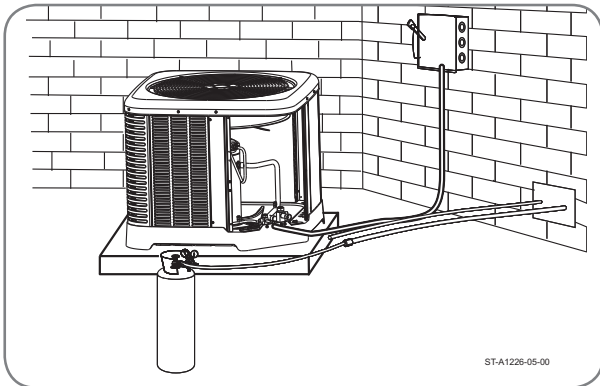

- Blow out the liquid and vapor lines with dry nitrogen before connecting to the outdoor unit and indoor coil. Any debris in the line set will end up plugging the expansion device.

Tubing Connections

Indoor coils have only a holding charge of dry nitrogen. Keep all tube ends sealed until connections are to be made.

- Use type “L” copper refrigeration tubing. Braze the connections with the following alloys:
 - copper to copper, 5% silver minimum
 - copper to steel or brass, 15% silver minimum

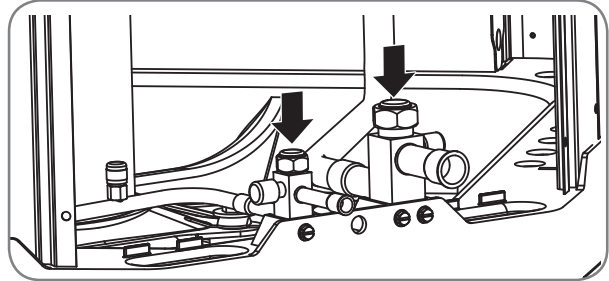

- Be certain both refrigerant shutoff valves at the outdoor unit are closed.

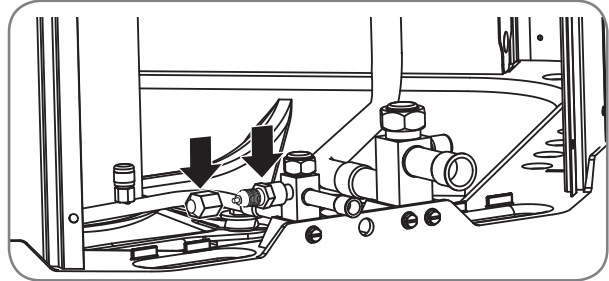

- Remove the caps and Schrader cores from the pressure ports to protect seals from heat damage. Both the Schrader valves and the service valves have seals that may be damaged by excessive heat.

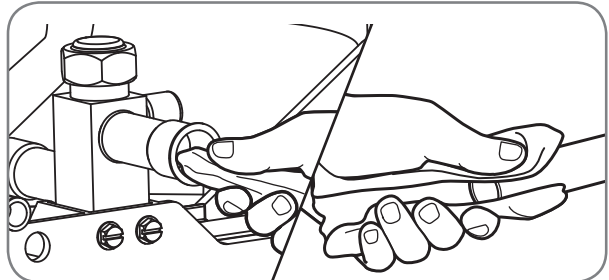

- Clean the inside of the fittings and outside of the tubing with a clean, dry cloth before soldering. Clean out debris, chips, dirt, etc., that enters tubing or service valve connections.

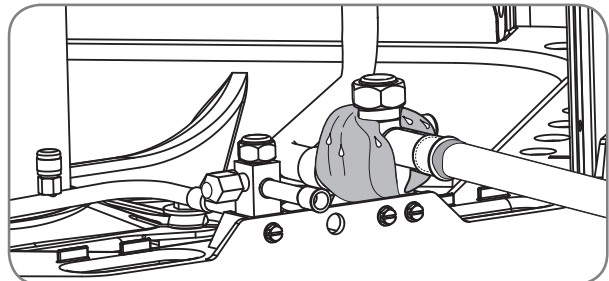

- Wrap valves with a wet rag or thermal barrier compound before applying heat.

INSTALLATION



Interconnecting Tubing (cont.)

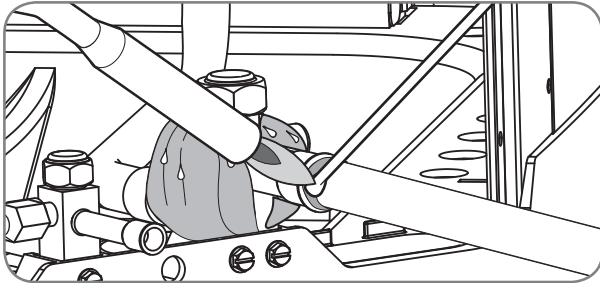

- Braze the tubing between the outdoor unit and indoor coil. Flow dry nitrogen into a pressure port and through the tubing while brazing, but do not allow pressure inside tubing which can result in leaks. Once the system is full of nitrogen, the nitrogen regulator should be turned off to avoid pressuring the system.

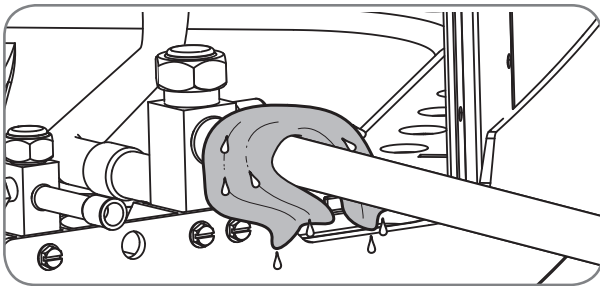

- After brazing, use an appropriate heatsink material to cool the joint.
- Reinstall the Schrader cores into both pressure ports.

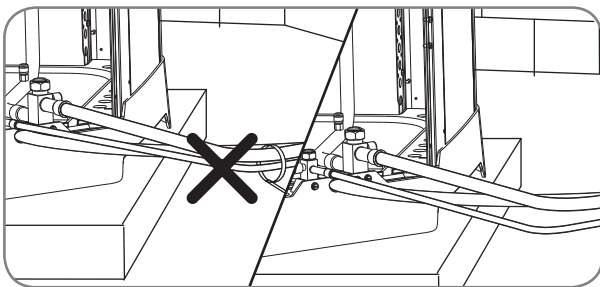

- Do not allow the vapor line and liquid line to be in contact with each other. This causes an undesirable heat transfer resulting in capacity loss and increased power consumption.

Leak Testing

Indoor coils have only a holding charge of dry nitrogen. Keep all tube ends sealed until connections are to be made.

⚠WARNING: Do not use oxygen to purge lines or pressurize system for leak test. Oxygen reacts violently with oil, which can cause an explosion resulting in severe personal injury or death.

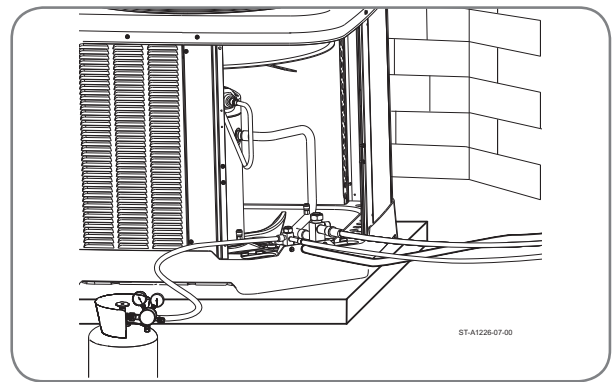

- Pressurize line set and coil through service fittings with dry nitrogen to 150 PSIG maximum. Close nitrogen tank valve, let system sit for at least 15 minutes, and check to see if the pressure has dropped. If the pressure has dropped, check for leaks at the line set braze joints with soap bubbles and repair leak as necessary. Repeat pressure test. If line set and coil hold pressure, proceed with line set and coil evacuation (see page 21).

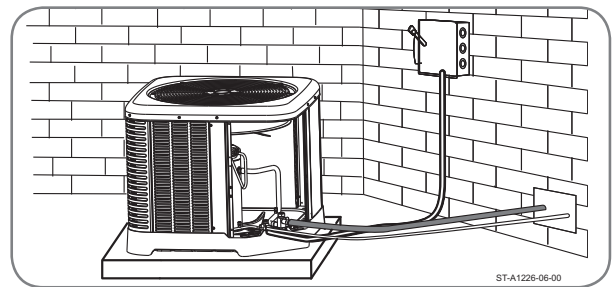

- The vapor line must be insulated for its entire length to prevent dripping (sweating) and prevent performance losses. Closed-cell foam insulation such as Armaflex and Rubatex® are satisfactory insulations for this purpose. Use 1/2" [12.7 mm] minimum insulation thickness. Additional insulation may be required for long runs.

WIRING



Control Wiring

⚠WARNING: Turn off electric power at the fuse box or service panel before making any electrical connections. Also, the ground connection must be completed before making line voltage connections. Failure to do so can result in electrical shock, severe personal injury, or death.

Control Wiring

Running low-voltage wires in conduit with line voltage power wires is not recommended. Low-voltage wiring may be run through the plastic bushing provided in the 7/8" [19 mm] hole in the base panel, up to and attached to the pigtails from the bottom of the control box. Conduit can be run to the base panel if desired by removing the insulated bushing.

A thermostat and a 24-volt, 40 VA minimum transformer are required for the control circuit of the system. The furnace or the air handler transformer may be used if sufficient. See the wiring diagram for reference. Use "Wire Size" table to size the 24-volt control wiring.

Do not use phone cord to connect indoor and outdoor units and thermostat. This could damage the controls and may not be adequately sized for the controls electrical load.

FIELD WIRE SIZE FOR 24-VOLT THERMOSTAT CIRCUITS

Thermostat Load (amps)	SOLID COPPER WIRE – AWG.						
	20 [6]	50 [15]	100 [30]	150 [46]	200 [51]	250 [76]	300 [91]
3.0	18	16	14	12	10	10	10
2.5	18	16	14	12	10	10	10
2.0	18	16	14	12	10	10	10
Length of Run – Feet [m] (1)							

(1) Wire length equals twice the run distance.

NOTICE: Do not use control wiring smaller than No. 18 AWG between thermostat and outdoor unit.

Typical Noncommunicating Thermostat Wiring Diagrams

The following figures show the typical wiring diagrams. Cooling airflows may need to be adjusted for homeowner comfort once the system is operational.

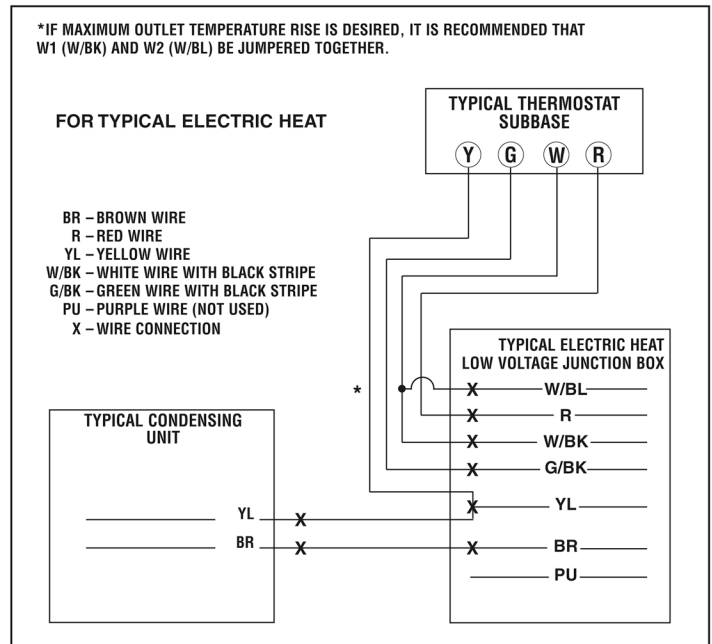
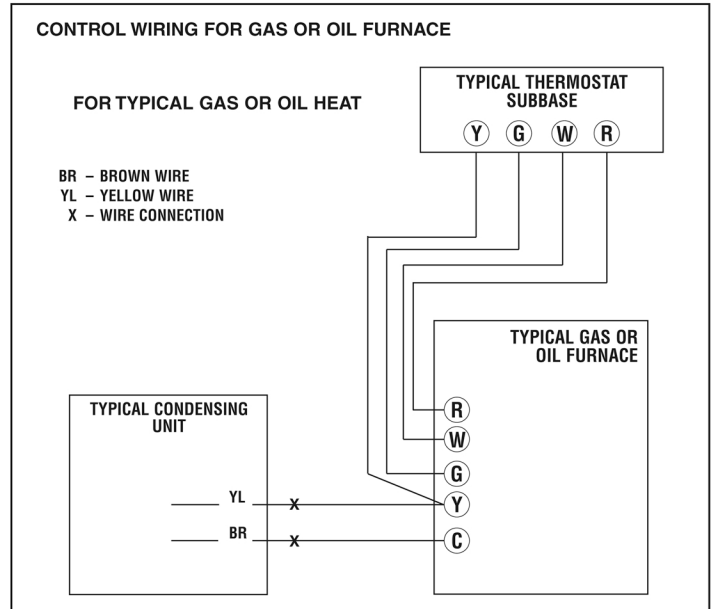

WIRE COLOR CODE		
BK – BLACK	GY – GRAY	W – WHITE
BR – BROWN	O – ORANGE	Y – YELLOW
BL – BLUE	PR – PURPLE	
G – GREEN	R – RED	



Control Wiring (cont.)

Field wiring must comply with the National Electric Code (C.E.C. in Canada) and any applicable local code.

Power Wiring

It is important that proper electrical power from a commercial utility is available at the compressor contactor. Voltage ranges for operation are shown below.

VOLTAGE RANGES (60 HZ)

Nameplate Voltage	Operating Voltage Range at Copeland Maximum Load Design Conditions for Compressors
208/230 (1 Phase)	187 - 253
208/230 (3 Phase)	187 - 253
460	414 - 506
575	517 - 633

Install a branch circuit disconnect within sight of the unit and of adequate size to handle the starting current (see “Electrical Data” on page 5.)

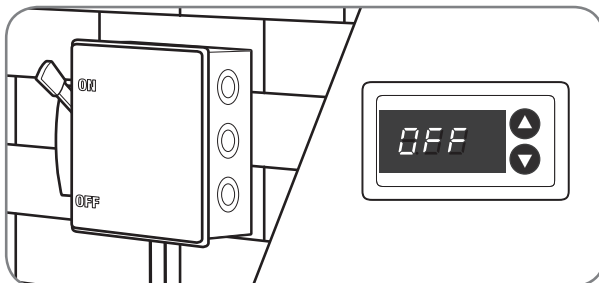

Power wiring must be run in a rain-tight conduit. Conduit must be run through the connector panel below the access cover (see page 6) and attached to the bottom of the control box.

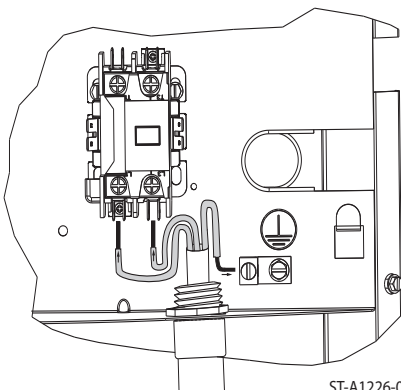

ST-A1226-09

Connect power wiring to line-voltage lugs located in the outdoor unit electrical box. (See wiring diagram attached to unit access panel.)

Check all electrical connections, including factory wiring within the unit and make sure all connections are tight.

DO NOT connect aluminum field wire to the contactor terminals.

Grounding

⚠WARNING: The unit must be permanently grounded. Failure to do so can cause electrical shock resulting in severe personal injury or death.

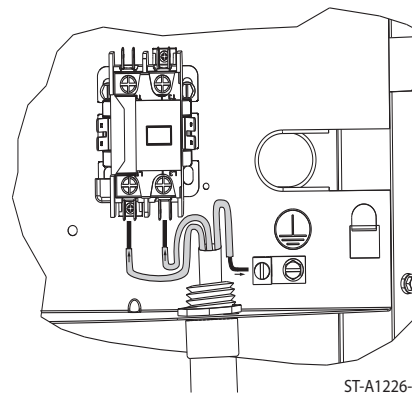

ST-A1226-09

A grounding lug is provided near the line-voltage power entrance for a ground wire.

START-UP



Start-Up

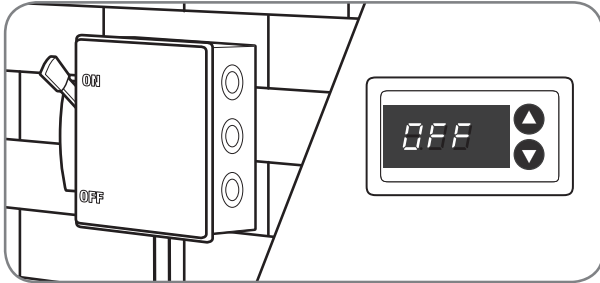

At initial start-up or after extended shutdown periods, make sure the crankcase heater is energized for at least 12 hours before the compressor is started. (Disconnect switch is on and wall thermostat is off.)

Even though the unit is factory-charged with Refrigerant-410A, the charge must be checked to the charge table attached to the service panel and adjusted, if required. Allow a minimum of 15 minutes of run time before analyzing charge.

CAUTION: Single-pole contactors are used on all standard single-phase units through 5 tons. Caution must be exercised when servicing as only one leg of the power supply is broken by the contactor.



Checking Airflow

The air distribution system has the greatest effect on airflow. The duct system is totally controlled by the contractor. For this reason, the contractor should use only industry-recognized procedures.

The correct air quantity is critical to air conditioning systems. Proper operation, efficiency, compressor life, and humidity control depend on the correct balance between indoor load and outdoor unit capacity. Excessive indoor airflow increases the possibility of high humidity problems. Low indoor airflow reduces total capacity can cause coil icing. Serious harm can be done to the compressor by low airflow, such as that caused by refrigerant flooding.

Air conditioning systems require a specified airflow. Each ton of cooling requires between 320 and 450 cubic feet of air per minute (CFM). See the manufacturer's spec sheet for rated airflow for the system being installed.

Duct design and construction should be carefully done. System performance can be lowered dramatically through bad planning or workmanship.

Air supply diffusers must be selected and located carefully. They must be sized and positioned to deliver treated air along the perimeter of the space. If they are too small for their intended airflow, they become noisy. If they are not located properly, they cause drafts. Return air grilles must be properly sized to carry air back to the blower. If they are too small, they also cause noise.

The installers should balance the air distribution system to ensure proper quiet airflow to all rooms in the home. This ensures a comfortable living space.

These simple mathematical formulas can be used to determine the CFM in a residential or light commercial system.

Electric resistance heaters can use:

$$\text{CFM} = \frac{\text{volts} \times \text{amps} \times 3.413}{\text{SHC} \times \text{temp rise}}$$

Gas furnaces can use:

$$\text{CFM} = \frac{\text{Output Capacity in BTUH}^*}{\text{SHC} \times \text{temp rise}}$$

*Refer to furnace data plate for furnace output capacity. SHC = Sensible Heat Constant (see table below)

An air velocity meter or airflow hood can give a more accurate reading of the system CFM.

The measurement for temperature rise should be performed at the indoor coil inlet and near the outlet, but out of direct line of sight of the heater element or heat exchanger. For best results, measure air temperature at multiple points and average the measurements to obtain coil inlet and outlet temperatures.

ALTITUDE (FEET)	SENSIBLE HEAT CONSTANT (SHC)	ALTITUDE (FEET)	SENSIBLE HEAT CONSTANT (SHC)
Sea Level	1.08	6000	0.87
500	1.07	7000	0.84
1000	1.05	8000	0.81
2000	1.01	9000	0.78
3000	0.97	10000	0.75
4000	0.94	15000	0.61
5000	0.90	20000	0.50



Evacuation and Leak Testing

Evacuation Procedure

Evacuation is the most important part of the entire service procedure. The life and efficiency of the equipment is dependent upon the thoroughness exercised by the serviceman when evacuating air and moisture from the system.

Air or nitrogen in the system causes high condensing temperatures and pressure, resulting in increased power input and nonverifiable performance.

Moisture chemically reacts with the refrigerant and oil to form corrosive hydrofluoric acid. This attacks motor windings and parts, causing breakdown.

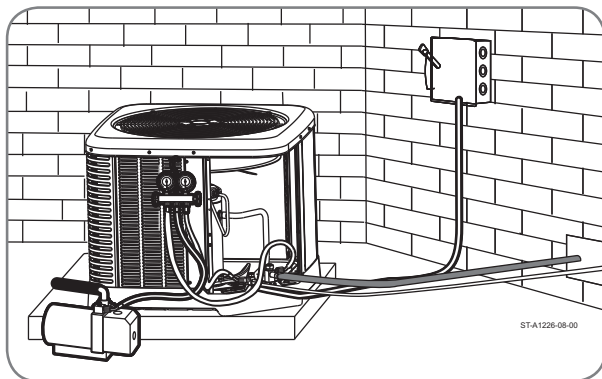

- After the system has been leak-checked and proven sealed, connect the vacuum pump and evacuate system to 500 microns and hold 500 microns or less for at least 15 minutes. The vacuum pump must be connected to both the high and low sides of the system by connecting to the two pressure ports. Use the largest size connections available since restrictive service connections may lead to false readings because of pressure drop through the fittings.

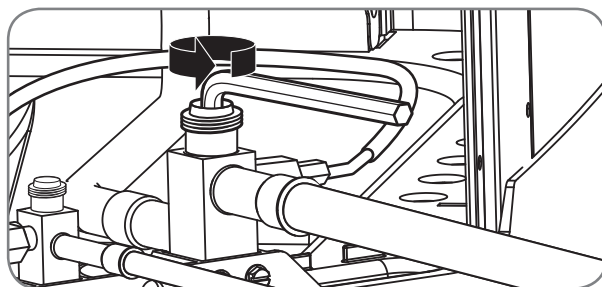

- After adequate evacuation, open both service valves by removing both brass service valve caps with an adjustable wrench. Insert a 3/16" [5 mm] or 5/16" [8 mm] hex wrench into the stem and turn counterclockwise until the wrench stops.

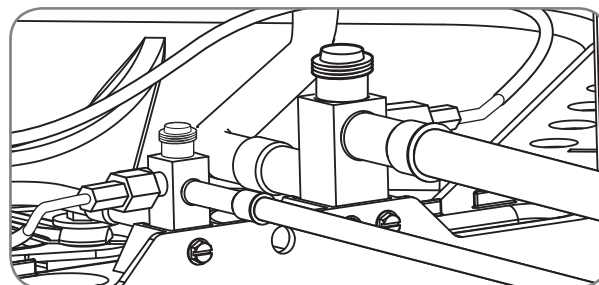

- Gauges must be connected at this point to check and adjust charge. Do not replace caps yet.

IMPORTANT: Compressors (especially scroll type) should never be used to evacuate the air conditioning system because internal electrical arcing may result in a damaged or failed compressor. Never run a scroll compressor while the system is in a vacuum or compressor failure will occur.

Final Leak Testing

After the unit has been properly evacuated and service valves opened, a halogen leak detector should be used to detect leaks in the system. All piping within the condenser, evaporator, and interconnecting tubing should be checked for leaks. If a leak is detected, the refrigerant should be recovered before repairing the leak. The Clean Air Act prohibits releasing refrigerant into the atmosphere.

START-UP



Checking Refrigerant Charge

Charge for all systems should be checked against the Charging Chart inside the access panel cover.

⚠WARNING: The top of the scroll compressor shell is hot. Touching the compressor top may result in serious personal injury.

IMPORTANT: Use factory-approved charging method as outlined on the next page to ensure proper system charge.

NOTICE: The optimum refrigerant charge for any outdoor unit matched with an indoor coil/air handler is affected by the application. Therefore, charging data has been developed to assist the field technician in optimizing the charge for all mounting configurations (UF – Upflow, DF – Downflow, LH – Left-Hand Discharge, and RH – Right-Hand Discharge). Refer to the charging chart inside the access panel cover on the unit and choose the appropriate column for the specific application being installed or serviced.

Charging Units With R-410A Refrigerant

⚠CAUTION: R-410A pressures are approximately 60% higher (1.6 times) than R-22 pressures. Use appropriate care when using this refrigerant. Failure to exercise care may result in equipment damage or personal injury.

Charge for all systems should be checked against the Charging Chart inside the access panel cover.

IMPORTANT: Do not operate the compressor without charge in the system.

Addition of R-410A will raise high-side pressures (liquid and discharge).

NOTICE: System maintenance is to be performed by a qualified and certified technician. The following method is used for charging systems in the cooling mode. All steps listed should be performed to ensure proper charge has been set. For measuring pressures, the service valve port on the liquid valve (small valve) and suction valve (large valve) are to be used

Confirm ID Airflow and Coils Are Clean

Confirm adequate indoor supply airflow prior to starting the system. See the Technical Specification Sheet for rated airflow for each ID/OD unit match. Air filter(s) and coils (indoor and outdoor) are to be clean and free of frost prior to starting the system.

Supply airflow must be between 320 and 450 cfm per rated cooling ton prior to adjusting system charge. If a humidification system is installed, disengage it from operation prior to charge adjustment. Refer to the “Checking Airflow” section of this manual for further instruction.

NOTICE: Verify system components are matched according to the outdoor unit Specification Sheet.

Measurement Device Setup

1. With an R-410A gauge set, attach the high-pressure hose to the access fitting on the liquid (small) service valve at the OD unit.
2. Attach the low-pressure hose to the access fitting on the suction (large) service valve.
3. Attach a temperature probe within 6" [15.2 cm] outside of the unit on the copper liquid line (small line). For more accurate measurements, clean the copper line prior to measurement and use a calibrated clamp-on temperature probe or an insulated surface thermocouple.

Charging by Weight

NOTICE: Adjust the system charge by weight for the straight length of the refrigerant line set.

For a new installation, evacuation of interconnecting tubing and indoor coil is adequate; otherwise, evacuate the entire system. Use the factory charge shown in “Electrical and Physical Data” on page 5 of these instructions or on the unit data plate. Note that the charge value includes charge required for 15 ft. [4.6 m] of standard-size interconnecting liquid line without a filter drier.

Calculate actual charge required with installed liquid line size and length using:

- 1/4" [6.4 mm] O.D. = .3 oz./ft. [8.5 g/.30 m]
- 5/16" [7.9 mm] O.D. = .4 oz./ft. [11.3 g/.30 m]
- 3/8" [9.5 mm] O.D. = .6 oz./ft. [17.0 g/.30 m]
- 1/2" [12.7 mm] O.D. = 1.2 oz./ft. [34.0 g/.30 m]

Add 6 oz. for field-installed filter drier.



Checking Refrigerant Charge (cont.)

With an accurate scale (+/- 1 oz. [28.3 g]) or volumetric charging device, adjust charge difference between that shown on the unit data plate and that calculated for the new system installation. If the entire system has been evacuated, add the total calculated charge.

IMPORTANT: Charging by weight is not always accurate since the application can affect the optimum refrigerant charge. Charging by weight is considered a starting point ONLY. Always check the charge by using the Charging Chart and adjust as necessary. CHARGING BY LIQUID SUBCOOLING MUST BE USED FOR FINAL CHARGE ADJUSTMENT.

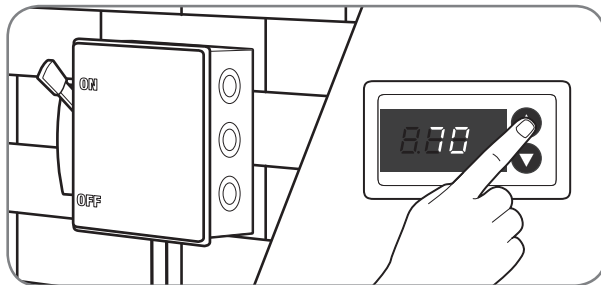

With thermostat in the “Off” position, turn on the power to the furnace or air handler and the condensing unit. Start the condensing unit and the furnace or air handler with the thermostat. Verify that the outdoor unit is operating and the indoor air mover is delivering the correct airflow for the system size.

Gross Charging by Pressures

1. Following airflow verification and charge weighing, run the unit for a minimum of 15 minutes prior to noting pressures and temperature.

IMPORTANT: Indoor conditions as measured at the indoor coil must be within 2°F [1.1°C] of the following during gross charge (pressure) evaluation:

Cooling Mode: 80°F [26.7°C] Dry Bulb

Heating Mode: 70°F [21.1°C] Dry Bulb

NOTICE: If the Indoor temperature is above or below this range, run the system to bring the temperature down or run the electric heat/furnace to bring the temperature within this range. System pressure values provided in the Charging Chart for outdoor dry bulbs corresponding to conditions outside of these ranges are provided as reference ONLY.

2. Note the Outdoor Dry Bulb Temperature, ODDB° = ____°F [____°C]. Unit charging is recommended under the following outdoor conditions ONLY:

Cooling Mode ONLY: 55°F [12.8°C] outdoor dry bulb and above

3. Locate and note the design pressures. The correct liquid and vapor pressures are found at the intersection of the installed system and the outdoor ambient temperature on the Charging Chart located inside the access panel cover.

Liquid Pressure: = ____psig; Vapor Pressure = ____psig

NOTICE: The refrigerant pressures provided are for gross charge check ONLY. These pressure values are typical, but may vary due to application. Evaporator load (indoor coil in cooling mode/outdoor coil in heating mode) will cause pressures to deviate. Note that all systems have unique pressure curves. The variation in the slope and value is determined by the component selection for that indoor/outdoor matched system. The variation from system to system seen in the table is normal. The values listed are for the applicable indoor coil match ONLY!

4. If the measured liquid pressure is below the listed requirement for the given outdoor and indoor conditions, add charge. If the measured liquid pressure is above the listed requirement for the given outdoor and indoor conditions, remove charge.

Final Charge by Subcooling

1. After gross charging, note the designed subcooling value. The correct subcooling value is found at the intersection of the installed system and the outdoor ambient temperature on the Charging Chart located inside the access panel cover.

SC° from Charging Chart = ____°F [____°C].

IMPORTANT: Indoor conditions as measured at the indoor coil are required to be between 70°F [21.1°C] and 80°F [26.7°C] dry bulb for fine-tuned unit charge adjustment. Unit charging is recommended under the following outdoor conditions ONLY:

Cooling Mode ONLY: 55°F [12.8°C] outdoor dry bulb and above

START-UP



Checking Refrigerant Charge (cont.)

Refrigerant

NOTICE: If the indoor temperature is above or below the recommended range, run the system to bring the temperature down or run the electric heat/furnace to bring the temperature up. System subcooling values provided in the Charging Chart for outdoor dry bulbs corresponding to conditions outside of the above range are provided as reference ONLY.

2. Note the measured Liquid Pressure, $P_{liq} =$ _____ psig, as measured from the liquid (small) service valve. Use the Temperature Pressure Chart below to note the corresponding saturation temperature for R-410A at the measured liquid pressure.

Liquid Saturation Temperature, $SAT^\circ =$ _____ $^\circ F$ [_____ $^\circ C$].

3. Note the liquid line temperature, $Liq^\circ =$ _____ $^\circ F$ [_____ $^\circ C$], as measured from a temperature probe located within 6" [15.2 cm] outside of the unit on the copper liquid line (small line). It is recommended to use a calibrated clamp-on temperature probe or an insulated surface thermocouple.

4. Subtract the liquid line temperature from the saturation temperature to calculate subcooling.
 SAT° _____ $^\circ F$ [_____ $^\circ C$] - Liq° _____ $^\circ F$ [_____ $^\circ C$] =
 SC° _____ $^\circ F$ [_____ $^\circ C$]

5. Adjust charge to obtain the specified subcooling value. If the measured subcool is below the listed requirement for the given outdoor and indoor

conditions, add charge. If the measured subcool is above the listed requirement for the given outdoor and indoor conditions, remove charge.

Finishing Up Installation

- Disconnect pressure gauges from pressure ports; then replace the pressure port caps and tighten adequately to seal caps. **Do not overtighten.**
- Replace the service valve caps finger-tight and then tighten with an open-end wrench adequately to seal caps. **Do not overtighten.**
- Replace control box cover and service panel and install screws to secure service panel.
- Restore power to unit at disconnect if required.
- Configure indoor thermostat per the thermostat installation instructions and set thermostat to desired mode and temperature.

NOTICE: Systems should not be fine-tune charged below 40°F [4.4°C] outdoor dry bulb.

IMPORTANT: Excessive use of elbows in the refrigerant line set can produce excessive pressure drop. Follow industry best practices for installation. Installation and commissioning of this equipment is to be performed by trained and qualified HVAC professionals. For technical assistance, contact your Distributor Service Coordinator.

TEMPERATURE PRESSURE CHART

SATURATION TEMP (Deg. F) [Deg. C]	R-410A PSIG	SATURATION TEMP (Deg. F) [Deg. C]	R-410A PSIG	SATURATION TEMP (Deg. F) [Deg. C]	R-410A PSIG	SATURATION TEMP (Deg. F) [Deg. C]	R-410A PSIG
-150 [-101]	-	-30 [-34]	17.9	35 [2]	107.5	100 [38]	317.4
-140 [-96]	-	-25 [-32]	22.0	40 [4]	118.5	105 [41]	340.6
-130 [-90]	-	-20 [-29]	26.4	45 [7]	130.2	110 [43]	365.1
-120 [-84]	-	-15 [-26]	31.3	50 [10]	142.7	115 [46]	390.9
-110 [-79]	-	-10 [-23]	36.5	55 [13]	156.0	120 [49]	418.0
-100 [-73]	-	-5 [-21]	42.2	60 [16]	170.1	125 [52]	446.5
-90 [-68]	-	0 [-18]	48.4	65 [18]	185.1	130 [54]	476.5
-80 [-62]	-	5 [-15]	55.1	70 [21]	201.0	135 [57]	508.0
-70 [-57]	-	10 [-12]	62.4	75 [24]	217.8	140 [60]	541.2
-60 [-51]	0.4	15 [-9]	70.2	80 [27]	235.6	145 [63]	576.0
-50 [-46]	5.1	20 [-7]	78.5	85 [29]	254.5	150 [66]	612.8
-40 [-40]	10.9	25 [-4]	87.5	90 [32]	274.3		
-35 [-37]	14.2	30 [-1]	97.2	95 [35]	295.3		

COMPONENTS AND CONTROLS



Compressor Crankcase Heat (CCH)

While scroll compressors usually do not require crankcase heaters, there are instances when a heater should be added. Refrigerant migration during the off cycle can result in a noisy start up. Add a crankcase heater to minimize refrigerant migration and to help eliminate any start up noise or bearing “wash out.”

NOTE: A crankcase heater should be installed if:

- The system charge exceeds the values listed in the adjacent tables,
- The system is subject to low voltage variations, or

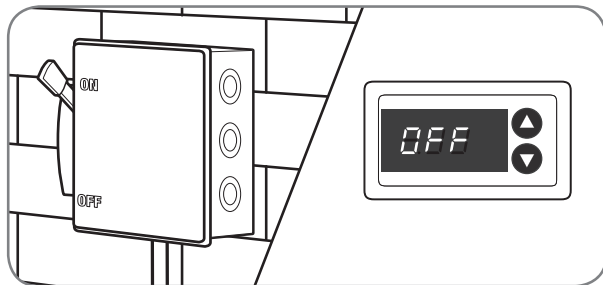

- When a low ambient control is used for system operation below 55°F.

All heaters are located on the lower half of the compressor shell. Its purpose is to drive refrigerant from the compressor shell during long off cycles, thus preventing damage to the compressor during start-up.

At initial start-up or after extended shutdown periods, make sure the heater is energized for at least 12 hours before the compressor is started. (Disconnect switch is on and wall thermostat is off.)

MAXIMUM SYSTEM CHARGE VALUES		
RA13 Model Size	Compressor Model Number	Charge Limit Without Crankcase Heat (1 Phase)
18AJ	ZP14KAE/ZP14K6E	9.6 lbs.
24AJ	ZP20KAE	9.6 lbs.
30AJ	ZP24K5E	9.6 lbs.
36AJ	ZP31K6E	9.6 lbs.
42AJ	ZP34K5E	12 lbs.
48AJ	ZP42K5E	12 lbs.
60AJ	ZP51K5E	12 lbs.
36AC	ZP31K6E-TF5	9.6 lbs.
42AC	ZP34K5E-TF5	12 lbs.
48AC	ZP42K5E-TF5	12 lbs.
60AC	ZP51K5E-TF5	12 lbs.
36AD	ZP31K6E-TFD	9.6 lbs.
42AD	ZP34K5E-TFD	12 lbs.
48AD	ZP42K5E-TFD	12 lbs.
60AD	ZP51K5E-TFD	12 lbs.
48AY	ZP42K5E-TFE	12 lbs.
60AY	ZP51K5E-TFE	12 lbs.

MAXIMUM SYSTEM CHARGE VALUES		
RA14 Model Size	Compressor Model Number	Charge Limit Without Crankcase Heat (1 Phase)
18AJ	ZP14KAE/ZP14K6E	9.6 lbs.
24AJ	ZP20KAE	9.6 lbs.
30AJ	ZP24K5E	9.6 lbs.
36AJ	ZP29K5E	9.6 lbs.
42AJ	ZP34K5E	12 lbs.
48AJ	ZP39K5E	12 lbs.
60AJ	ZP49K6E	12 lbs.
36AC	ZP31K6E-TF5	9.6 lbs.
42AC	ZP34K5E-TF5	12 lbs.
48AC	ZP42K5E-TF5	12 lbs.
60AC	ZP51K5E-TF5	12 lbs.
36AD	ZP31K6E-TFD	9.6 lbs.
42AD	ZP34K5E-TFD	12 lbs.
48AD	ZP42K5E-TFD	12 lbs.
60AD	ZP51K5E-TFD	12 lbs.

MAXIMUM SYSTEM CHARGE VALUES		
RA16 Model Size	Compressor Model Number	Charge Limit Without Crankcase Heat (1 Phase)
18AJ	ZP14K6E	9.6 lbs.
24AJ	ZP21K6E	9.6 lbs.
30AJ	ZP24K6E	9.6 lbs.
36AJ	ZP31K6E	9.6 lbs.
42AJ	ZP34K6E	12 lbs.
48AJ	ZP38K6E	12 lbs.
60AJ	ZP49K6E	12 lbs.
60BJ	ZP49K6E	12 lbs.
36AC	ZP31K6E-TF5	12 lbs.
42AC	ZP34K6E-TF5	12 lbs.
48AC	ZP38K6E-TF5	12 lbs.
60AC	ZP49K6E-TF5	12 lbs.



High- and Low-Pressure Controls (HPC and LPC)

HPC and LPC are not installed on RA13**AJINA, but can be field installed using the following kit numbers: RXAB-A0z (high pressure control) and RXAC-A0Z (low pressure control). These controls keep the compressor from operating in pressure ranges which can cause damage to the compressor. Both controls are in the low-voltage control circuit.

The high-pressure control (HPC) is an automatic-reset which opens near 610 PSIG and closes near 420 PSIG.

The low-pressure control (LPC) is an automatic-reset which opens near 15 PSIG and closes near 40 PSIG.

CAUTION: The compressor has an internal overload protector. Under some conditions, it can take up to 2 hours for this overload to reset. Make sure overload has had time to reset before condemning the compressor.

ACCESSORIES

⚠WARNING: Turn off electric power at the fuse box or service panel before making any electrical connections. Also, the ground connection must be completed before making line voltage connections. Failure to do so can result in electrical shock, severe personal injury, or death.

⚠CAUTION:
SINGLE POLE COMPRESSOR CONTACTOR (CC):

Single pole contactors are used on all single-phase units up through 5 tons. Caution must be exercised when servicing as only one leg of the power supply is broken with the contactor.

**Time Delay Control
(Part No. RXMD-B01)**

The time delay control is in the low voltage control circuit. When the compressor shuts off due to a power failure or thermostat operation, this control keeps it off at least 5 minutes which allows the system pressure to equalize, thus not damaging the compressor or blowing fuses on start-up.

**Low Ambient Control (LAC)
(Part No. RXAD-A08)**

This component senses compressor head pressure and shuts the heat pump fan off when the head pressure drops to approximately 250 PSIG. This allows the unit to build a sufficient head pressure at lower outdoor ambient (down to 0°F [-18°C]) in order to maintain system balance and obtain improved capacity. Low ambient control should be used on all equipment operated below 70°F [21°C] ambient.



Hard Start Components

Start components are not usually required with the scroll compressors used in RA13 condensing units, but are available for special cases and where start components are desirable to reduce light dimming.

DIAGNOSTICS

Electrical Checks Flowchart

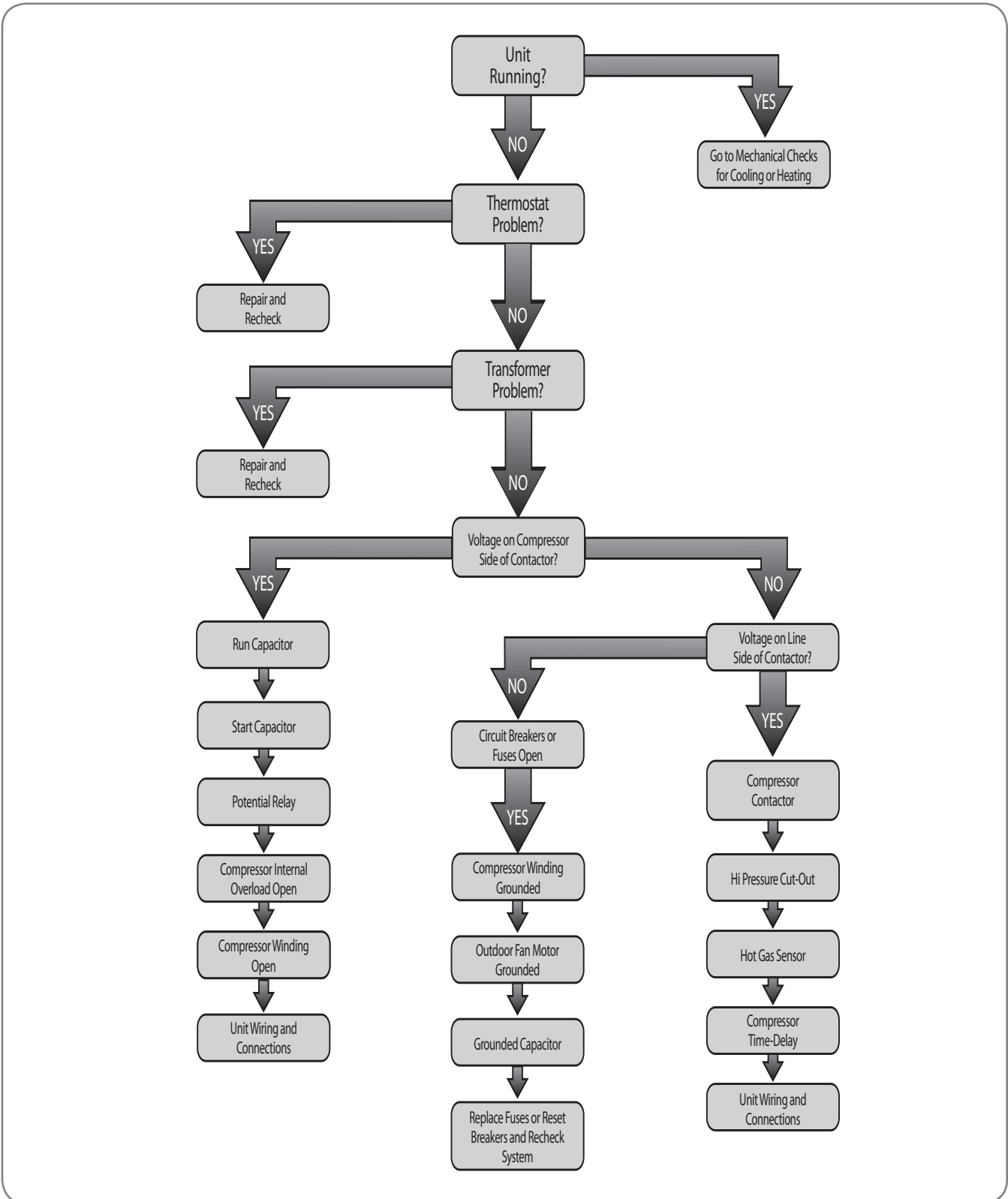

DIAGNOSTICS

Cooling Mechanical Checks Flowchart

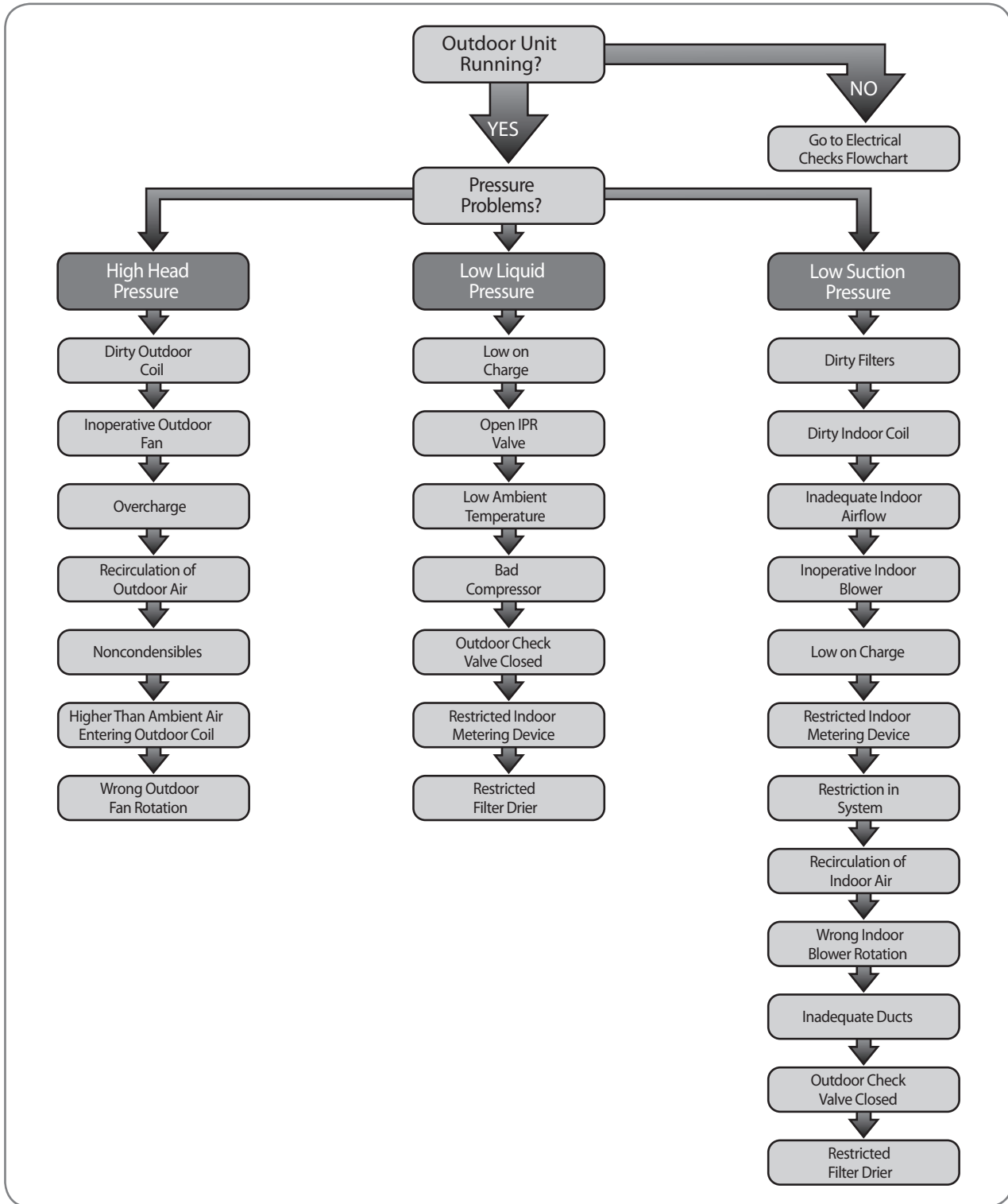

General Troubleshooting Chart

⚠WARNING: Disconnect all power to unit before servicing. Contactor may break only one side. Failure to shut off power can cause electrical shock resulting in personal injury or death.

SYMPTOM	POSSIBLE CAUSE	REMEDY
Unit will not run	<ul style="list-style-type: none"> Power off or loose electrical connection Thermostat out of calibration – set too high Defective control board Blown fuses/tripped breaker Transformer defective High-pressure control open Low-pressure control open Miswiring of communications (communication light on continuously) 	<ul style="list-style-type: none"> Check for correct voltage at line voltage connections in condensing unit. Reset. Check control board diagnostic codes. Replace fuses/reset breaker. Check wiring. Replace transformer. Reset. Also see high head pressure remedy. The high-pressure control opens at 610 PSIG. Check communication wiring.
Outdoor fan runs, compressor doesn't	<ul style="list-style-type: none"> Run or start capacitor defective Contactors defective Loose connection Compressor stuck, grounded or open motor winding, open internal overload. Low-voltage condition 	<ul style="list-style-type: none"> Replace. Replace. Check for correct voltage at compressor. Check and tighten all connections. Wait at least 3 hours for overload to reset. If still open, replace the compressor. Add start kit components.
Insufficient cooling	<ul style="list-style-type: none"> Improperly sized unit Improper indoor airflow Incorrect refrigerant charge Air, noncondensibles, or moisture in system Bad ID TXV 	<ul style="list-style-type: none"> Recalculate load. Check. Should be approximately 400 CFM per ton. Charge per procedure attached to unit service panel. Recover refrigerant. Evacuate and recharge. Add filter drier. Replace TXV
Compressor short cycles	<ul style="list-style-type: none"> Incorrect voltage Defective overload protector Refrigerant undercharge 	<ul style="list-style-type: none"> At compressor terminals, voltage must be $\pm 10\%$ of nameplate marking when unit is operating. Replace. Check for correct voltage. Add refrigerant.
Registers sweat	<ul style="list-style-type: none"> Low indoor airflow 	<ul style="list-style-type: none"> Increase speed of blower or reduce restriction. Replace air filter.
High head, low vapor pressures	<ul style="list-style-type: none"> Restriction in liquid line, expansion device, or filter drier Bad TXV 	<ul style="list-style-type: none"> Remove or replace defective component. Replace TXV.
High head, high or normal vapor pressure – Cooling mode	<ul style="list-style-type: none"> Dirty outdoor coil Refrigerant overcharge Outdoor fan not running Air or noncondensibles in system 	<ul style="list-style-type: none"> Clean coil. Correct system charge. Repair or replace. Recover refrigerant. Evacuate and recharge.
Low head, high vapor pressures	<ul style="list-style-type: none"> Bad TXV Bad compressor 	<ul style="list-style-type: none"> Replace TXV. Replace compressor.
Low vapor, cool compressor, iced indoor coil	<ul style="list-style-type: none"> Low indoor airflow Operating below 65°F outdoors Moisture in system Closed ID circuit 	<ul style="list-style-type: none"> Increase speed of blower or reduce restriction. Replace air filter. Add Low Ambient Kit. Recover refrigerant. Evacuate and recharge. Add filter drier. Repair or replace ID coil
High vapor pressure	<ul style="list-style-type: none"> Excessive load Defective compressor 	<ul style="list-style-type: none"> Recheck load calculation. Replace.
Fluctuating head and vapor pressures	<ul style="list-style-type: none"> TXV hunting Air or noncondensibles in system 	<ul style="list-style-type: none"> Check TXV bulb clamp. Check air distribution on coil. Replace TXV. Recover refrigerant. Evacuate and recharge.
Gurgle or pulsing noise at expansion device or liquid line	<ul style="list-style-type: none"> Air or noncondensibles in system 	<ul style="list-style-type: none"> Recover refrigerant. Evacuate and recharge.

DIAGNOSTICS

Service Analyzer Charts

COMPRESSOR OVERHEATING			
SYMPTOM	POSSIBLE CAUSE	CHECK/REMEDY	
High superheat (greater than 15°F [-9°C] at coil)	Low charge	Check system charge.	
	Faulty metering device	Restricted cap tube, TEV (TXV)	Power element superheat out of adjustment internally
		Foreign matter stopping flow	
		High internal load	Hot air (attic) entering return Heat source on; miswired or faulty control
	Restriction in liquid line	Drier plugged.	
		Line kinked.	
	Low head pressure	Low charge	Operating in low ambient temperatures
		Suction or liquid line subjected to high heat source	Hot attic / insulate liquid line
			Hot water line
	Low line voltage	Loose wire connections	Check wiring.
Power company problem, transformer		Have problem corrected before diagnosis continues.	
Undersized wire feeding unit		Correct and complete diagnosis.	
High line voltage	Power company problem	Have problem corrected.	
High head pressure	Overcharge	Check system charge.	
	Dirty outdoor coil	Clean coil.	
	Faulty or wrong size outdoor fan motor	Replace fan motor.	
	Faulty fan blade or wrong rotation	Replace fan blade.	
		Replace with correct rotation motor.	
	Recirculation of air	Correct installation.	
	Additional heat source	Check for dryer vent near unit.	
		Check for recirculation from other equipment.	
Noncondensibles	Recover refrigerant. Evacuate and recharge system.		
Equipment not matched	Correct mismatch.		
Short cycling of compressor	Faulty pressure control	Replace pressure control.	
	Loose wiring	Check unit wiring.	
	Thermostat	Located in supply air stream	
		Differential setting too close	
		Customer misuse	
	TEV	Internal foreign matter	
		Power element failure	
		Valve too small	
		Distributor tube/tubes restricted	
	Distributor tube	Restricted with foreign matter	
Kinked			
I.D. reduced from previous compressor failure			

Service Analyzer Charts

COMPRESSOR OVERHEATING (cont.)		
SYMPTOM	POSSIBLE CAUSE	CHECK OR REMEDIES
Short cycling of compressor (cont.)	Low charge	Check system charge.
	Low evaporator airflow	Dirty coil
		Dirty filter
		Duct too small or restricted
	Faulty run capacitor	Replace.
Faulty internal overload	Replace compressor.	
Faulty Compressor Valves	Fast equalization/Low pressure difference	Replace compressor and examine system to locate reason.
ELECTRICAL		
SYMPTOM	POSSIBLE CAUSE	CHECK OR REMEDIES
Voltage present on load side of compressor contactor and compressor won't run	Compressor start components	Check start capacitor.
		Check potential relay.
	Run capacitor	Check with ohmmeter
	Internal overload	Allow time to reset.
Voltage present on line side of compressor contactor only	Compressor windings	Check for correct ohms.
	Thermostat	Check for control voltage to contactor coil.
	Compressor control circuit	High-pressure switch
		Low-pressure switch
		Ambient thermostat
Solid-state protection control or internal thermal sensors		
Compressor timed off/on control or interlock		
No voltage on line side of compressor contactor	Blown fuses or tripped circuit breaker	Check for short in wiring or unit.
	Improper wiring	Recheck wiring diagram.
Improper voltage	High voltage	Wrong unit
		Power supply problem
	Low voltage	Wrong unit
		Power supply problem
		Wiring undersized
		Loose connections
Single Phasing (3 phase)	Check incoming power and fusing.	
FLOODED STARTS		
SYMPTOM	POSSIBLE CAUSE	CHECK OR REMEDIES
Liquid in the compressor shell	Faulty or missing crankcase heater	Replace crankcase heater.
Too much liquid in system	Incorrect piping	Check piping guidelines.
	Overcharge	Check and adjust charge.

DIAGNOSTICS

Service Analyzer Charts

CONTAMINATION		
SYMPTOM	POSSIBLE CAUSE	REMEDY
Moisture	Poor evacuation on installation or during service	In each case, the cure is the same. Recover refrigerant. Add filter drier, evacuate, and recharge.
High head pressure	Noncondensibles air	
Unusual head and suction readings	Wrong refrigerant or mixed refrigerants	
Foreign matter – copper filings	Copper tubing cuttings	
Copper oxide	Dirty copper piping or nitrogen not used when brazing	
Welding scale	Nitrogen not used during brazing	
Soldering flux	Adding flux before seating copper partway	
Excess soft solder	Wrong solder material	
LOSS OF LUBRICATION		
SYMPTOM	POSSIBLE CAUSE	REMEDY
Compressor failures	Line tubing too large	Reduce pipe size to improve oil return.
Low suction pressure	Low charge	Check system charge.
	Refrigerant leaks	Repair and recharge.
Cold, noisy compressor – Slugging	Dilution of oil with refrigerant	Observe piping guidelines.
Noisy compressor	Migration	Check crankcase heater.
Cold, sweating compressor	Flooding	Check system charge.
Low load	Reduced airflow	Dirty filter
		Dirty coil
		Wrong duct size
		Restricted duct
	Thermostat setting	Advise customer.
Short cycling of compressor	Faulty high- or low-pressure control	Replace control.
	Loose wiring	Check all control wires.
	Thermostat	In supply air stream, out of calibration
		Customer misuse
SLUGGING		
SYMPTOM	POSSIBLE CAUSE	REMEDY
On start-up	Incorrect piping	Review pipe size guidelines.
TEV hunting when running	Faulty TEV	Replace TEV.

Service Analyzer Charts

FLOODING		
SYMPTOM	POSSIBLE CAUSE	REMEDY
Poor system control using a TEV	Loose sensing bulb	Secure the bulb and insulate.
	Bulb in wrong location	Relocate bulb.
	Wrong size TEV	Use correct replacement.
	Improper superheat setting (less than 5°F [-15°C])	Replace TEV.
THERMOSTATIC EXPANSION VALVES		
SYMPTOM	POSSIBLE CAUSE	REMEDY
High Superheat, Low Suction Pressure (superheat over 15°F [-9°C])	Moisture freezing and blocking valve	Recover charge, install filter-drier, evacuate system, recharge.
	Dirt or foreign material blocking valve	Recover charge, install filter-drier, evacuate system, recharge.
	Low refrigerant charge	Correct the charge.
	Vapor bubbles in liquid line	Remove restriction in liquid line. Correct the refrigerant charge.
		Remove noncondensable gases.
		Size liquid line correctly.
	Misapplication of internally equalized valve	Use correct TEV.
	Plugged external equalizer line	Remove external equalizer line restriction.
	Undersized TEV	Replace with correct valve.
	Loss of charge from power head sensing bulb	Replace power head or complete TEV.
Charge migration from sensing bulb to power head (Warm power head with warm, wet cloth. Does valve operate correctly now?)	Ensure TEV is warmer than sensing bulb.	
Valve feeds too much refrigerant, with low superheat and higher than normal suction pressure	Moisture causing valve to stick open.	Recover refrigerant, replace filter-drier, evacuate system, and recharge.
	Dirt or foreign material causing valve to stick open	Recover refrigerant, replace filter drier, evacuate system, and recharge.
	TEV seat leak (a gurgling or hissing sound is heard AT THE TEV during the off cycle, if this is the cause). NOT APPLICABLE TO BLEED PORT VALVES.	Replace the TEV.
	Oversized TEV	Install correct TEV.
	Incorrect sensing bulb location	Install bulb with two mounting straps, in 2:00 or 4:00 position on suction line, with insulation.
	Low superheat adjustment	Replace TEV.
	Incorrectly installed, or restricted external equalizer line	Remove restriction, or relocate external equalizer.

DIAGNOSTICS

Service Analyzer Charts

THERMOSTATIC EXPANSION VALVES (cont.)		
SYMPTOM	POSSIBLE CAUSE	REMEDY
Compressor flood back upon start-up	Refrigerant drainage from flooded evaporator	Install trap riser to the top of the evaporator coil.
	Inoperable crankcase heater or crankcase heater needed	Replace or add crankcase heater.
	Any of the causes listed under symptoms of Electrical problems on page 45	Any of the solutions listed under solutions of Electrical problems on page 45
Superheat is low to normal with low suction pressure	Unequal evaporator circuit loading	Ensure airflow is equally distributed through evaporator. Check for blocked distributor tubes.
	Low load or airflow entering evaporator coil	Ensure blower is moving proper air CFM.
		Remove/Correct any airflow restriction.
Superheat and suction pressure fluctuate (valve is hunting)	Expansion valve is oversized	Install correct TEV.
	Sensing bulb is affected by liquid refrigerant or refrigerant oil flowing through suction line	Relocate sensing bulb in another position around the circumference of the suction line.
	Unequal refrigerant flow through evaporator circuits	Ensure sensing bulb is located properly.
		Check for blocked distributor tubes.
	Moisture freezing and partially blocking TEV	Recover refrigerant, change filter-drier, evacuate system, and recharge.
Valve does not regulate at all	External equalizer line not connected or line plugged	Connect equalizer line in proper location, or remove any blockage.
	Sensing bulb lost its operating charge	Replace TEV.
	Valve body damaged during soldering or by improper installation	Replace TEV.

DIAGNOSTICS

COOLING MODE TROUBLESHOOTING TIPS					
SYSTEM PROBLEM	INDICATORS				
	DISCHARGE PRESSURE	SUCTION PRESSURE	SUPERHEAT Normal: 5°–15°F [-15° – -9°C]	SUBCOOLING Normal: See Charging Chart	COMPRESSOR AMPS
Overcharge	High	High	Low	High	High
Undercharge	Low	Low	High	Low	Low
Liquid Restriction (Drier)	Low	Low	High	High	Low
Low Indoor Airflow	Low	Low	Low	Low	Low
Dirty Outdoor Coil	High	High	Low	Low	High
Low Outdoor Ambient Temperature	Low	Low	High	High	Low
Inefficient Compressor	Low	High	High	High	Low
Indoor TXV Feeler Bulb Charge Lost	Low	Low	High	High	Low
Poorly Insulated Indoor Sensing Bulb	High	High	Low	Low	High

WIRING DIAGRAMS

For Single-Phase Models

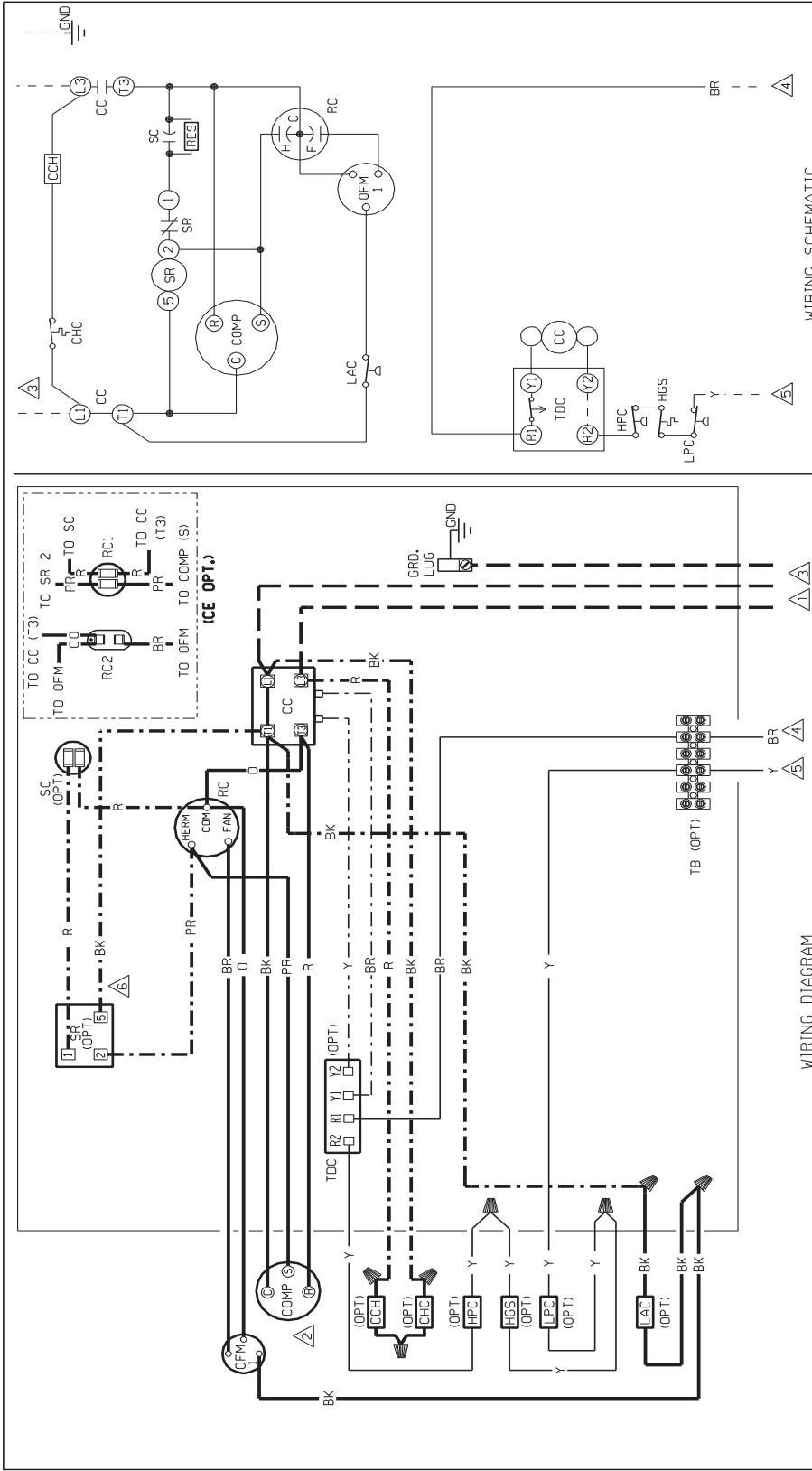

WIRING DIAGRAM

WIRING SCHEMATIC

COMPONENT CODE

- CC COMPRESSOR CONTACTOR
- CHC CRANKCASE HEATER CONTROL
- CHS COOLING FAN SENSOR
- COMP COMPRESSOR
- HPC HIGH PRESS. CUT-OUT CONTROL
- HGS HIGH GAS SENSOR
- LAC LOW AMBIENT COOLING CONTROL
- LPC LOW PRESSURE CONTROL
- OPM OUTDOOR FAN MOTOR
- PTCR POSITIVE TEMPERATURE COEFFICIENT RELAY
- RES RESISTOR
- SC START CAPACITOR
- SR START RELAY
- TDC TERMINAL BLOCK
- Y YELLOW
- BK BLACK
- BR BROWN
- R RED

NOTES:

1. CONNECTORS SUITABLE FOR USE WITH COPPER CONDUCTORS ONLY.
2. COMPRESSOR MOTOR, THERMALLY PROTECTED AND ALL 3 PHASE ARE PROTECTED UNDER PRIMARY SINGLE PHASE CONDITIONS.
3. CONNECT FAN WIRING IN GROUNDED RAINLIGHT CONDUIT TO USED DISCONNECT, VOLTAGE, HERTZ AND PHASE PER RATING PLATE.
4. LOW VOLTAGE CIRCUIT TO BE N.E.C. CLASS 2 WITH A CLASS 2 TRANSFORMER 24 VOLTS, 50 OR 60 HERTZ.
5. TO THERMOSTAT SUB-BASE, REFER TO SYSTEM SCHEMATICS OR SCHEMATICS ON INDOOR SECTION FOR LOW VOLTAGE CONTROL WIRING.
6. BLACK WIRE FROM SR (5) TO CC (1) DELETED WHEN PTCR IS USED.

WIRE COLOR CODE

- BK BLACK
- BR BROWN
- BL BLUE
- G GREEN
- GY GRAY
- O ORANGE
- PK PINK
- PR PURPLE
- R RED
- W WHITE
- Y YELLOW

ELECTRICAL WIRING DIAGRAM
REMOTE AIR CONDITIONER
SINGLE PHASE

DR. BY	APP. BY	DATE	DWG. NO.	REV
MB		1-28-92	90-23238-01	15

NOTES

A large, empty rectangular box with rounded corners, designed for taking notes. It contains 25 horizontal lines spaced evenly down the page, providing a structured area for writing.

